



Sistemi Distribuiti

Corso di Laurea in Ingegneria

Prof. Paolo Nesi

2014 parte 7a: Sistemi Mobili, e Sensori su mobile

Dipartimento di Ingegneria dell'Informazione, University of Florence

Via S. Marta 3, 50139, Firenze, Italy

tel: +39-055-4796523, fax: +39-055-4796363

DISIT Lab

<http://www.disit.dinfo.unifi.it/>

paolo.nesi@unifi.it



Sommario



- | Problematiche dei sistemi mobili
- | Confronti fra SO e modelli di sviluppo
- | Distribuzione di contenuti per sistemi mobili
- | Modello di Programmazione iPhone
 - ♣ Si veda slide separate Parte 7a
- | Modello di Programmazione Android
- | Mobile Medicine
 - ♣ Windows Mobile
 - ♣ iPhone/iPad
 - ♣ Android
- | Content Organizer
- | Mobile Emergency
- | Mobiles and Sensors



ITALIA DEGLI INNOVATORI

Agenzia per la Diffusione delle Tecnologie per l'Innovazione
Presidenza del Consiglio dei Ministri



ITALIA DEGLI INNOVATORI

Agenzia per la Diffusione delle Tecnologie per l'Innovazione
Presidenza del Consiglio dei Ministri

New C



n Bluetooth

n WiFi

n GSM, UMTS

n Edge, ...

n TCP/IP...based





Sistemi Mobili

- | In commercio vi sono moltissimi sistemi mobili
- | I sistemi mobili hanno una penetrazione > 93%
- | Sono sistemi molto diversi fra di loro ma che comunicano tramite
 - ♣ Diversi protocolli: WAP, HTML, etc.
 - ➔ TAC, GSM, UMTS, etc.
 - ➔ UMTS, GPRS, EDGE, HSDPA
 - ♣ Diversi meccanismi: SMS, MMS, email, etc.
 - ♣ ...

Sistemi Mobili e Wireless

Ubiquitous Computing

- ♣ Da tutte le parti in modo concorrente

Pervasive Computing

- ♣ dove non è evidente

Wearable Computers

- ♣ indossabili

PDA, Tablet PC and future applications

- ♣ Telecomando universale
- ♣ Navigatore personale
- ♣ Verifica delle letture del GAS....
- ♣ Sensor network
- ♣ Device Monitoring





Major problems of mobiles/moves

| Integration of paradigms:

- ♣ human, data and physically-driven

| Movements of the device

♣ Pros:

- ➔ Usable “anyware”
- ➔ detection can be useful to create context aware applications
- ➔ Services for the users

♣ Cons:

- ➔ non predictable connection
- ➔ frequently disconnection, cell change, etc.
- ➔ coverage of the reference server/net/cell



Major problems of mobiles/moves

Exploitation of movements/localization

♣ Sensors:

- metal detector,
- RFID, GPS, Wifi Position IP, compass, gyros, accelerometers,
- Camera, QR...

♣ Exploiting movement profile

- Reasoning about behavior
- Context aware applications, discovering
- Clustering with other mobiles

♣ Exploiting spatial knowledge

- Location management
 - Content Geo tagging
 - Tracking user position
 - Privacy of the location



Major problems of mobiles/moves

Discontinuity of connection

- ♣ Discovery
 - ➔ Cell, net, Services
 - ➔ Discovering of other mobiles
- ♣ Registration security, etc.
- ♣ Transparent maintenance of:
 - ➔ Connectivity
 - ➔ Access to services and resources
 - Redirection of services/resources
 - ➔ Migration
 - profile and registration
 - Disconnection
 - ➔ Security of access and migration
- ♣ Quality of Service
- ♣ Etc.



Major problems of mobiles/moves

Heterogeneity

- ♣ Standardization
 - ➔ Protocols, etc.
- ♣ Devices
 - ➔ Different CPUs, different hardware
- ♣ operating systems
 - ➔ Largely without multitasking/threading
- ♣ Asymmetric bandwidth
- ♣ Low foot print
 - ➔ Limited resources
 - ➔ Short battery life
- ♣ Profiling:
 - ➔ device capabilities
 - Different players
 - Different java profiles
 - ➔ user preferences

Sommario



Problematiche dei sistemi mobili

Confronti fra SO e modelli di sviluppo

Distribuzione di contenuti per sistemi mobili

Modello di Programmazione iPhone

♣ Si veda slide separate Parte 7a

Modello di Programmazione Android

Mobile Medicine

♣ Windows Mobile

♣ iPhone/iPad

♣ Android

Content Organizer

Mobile Emergency

Mobiles and Sensors



ITALIA DEGLI INNOVATORI

Agenzia per la Diffusione delle Tecnologie per l'Innovazione
Presidenza del Consiglio dei Ministri



ITALIA DEGLI INNOVATORI

Agenzia per la Diffusione delle Tecnologie per l'Innovazione
Presidenza del Consiglio dei Ministri



Operating Systems for Mobiles

2009	Sony/ Ericson	Mot orol a	Nok ia	Sams ung	Acer	Palm	LG	Black Berry, RIM	IPh one	HTC
Microsoft		X		X	X	X	X			X
Palm						X				
Symbian, OVI	(X)		X	X			(X)			
Linux, Limo		X					X			
Apple									X	
Android		[X]		[X]	[X]					X
(Proprietary os)		(X)		X						
BlackBerry								X		



More on OS for mobiles

- | (.) it was in the past
- | [.] it has been planned in the future
- | LIMO has also
 - ♣ Nec, Panasonic, NTT, Samsung, LG, ..
- | Microsoft Windows Mobile has also:
 - ♣ LG, Asus, iMate, ETEN, OS2,...



Mobile comparison, IEEE Computer 2011

Table 1. Overview of popular smartphone systems.

Property	Android Linux	iPhone OS	Java ME MIDP	MeeGo Linux	Symbian Series 60	Windows Mobile .NET and Windows Phone 7
Development	Java, native code with JNI and C/C++	Objective-C	Java ME	C/C++, Qt APIs, various	C++, Qt, Python, various	C# and .NET, Silverlight, various
Network and energy monitoring/control	Several APIs	Limited API support, battery monitoring since 3.0	No	Several APIs, native calls	Yes	Yes (limited in WP7)
Background processing	Yes (services)	No (yes for 4.0)	Yes (multitasking support in MIDP 3.0)	Yes	Yes	Yes, not supported for third-party applications in WP7
HTML5	Yes, support depends on version	Yes	N/A	Yes, support depends on version	Yes, future versions	No, expected in future versions
SIP API support	Yes, support depends on version	Extension	Extension	Yes	Yes	No, possibly in future versions
Open source	Yes	No	No	Yes	Yes	No
Third-party application installation	Certificate, Android market	Certificate, Apple App Store	Certificate	Certificate	Certificate	Certificate, WP7 apps marketplace

Differenze:

Modelli di Sviluppo per Mobile



| Multimedia

- ♣ Differenze sostanziali nelle primitive HW/SW a disposizione
- ♣ Video, audio, etc.

| JVM Differenze sostanziali ormai in disuso

- ♣ nel tipo di profilo e di versione di midlet che si puo' utilizzare
- ♣ Per moduli aggiuntivi: XML, MMAPI, SSL, etc.

| Modelli di certificazione e certificati per applicazioni mobili

| Deployment sul dispositivo,

- ♣ Modello di installazione
- ♣ fortemente dipendente dal sistema operativo

| Sistemi di sviluppo

- ♣ specifici non solo per Marca ma anche per tipo, serie, e ovviamente per Operating System



World-Wide Smartphone Sales (%)

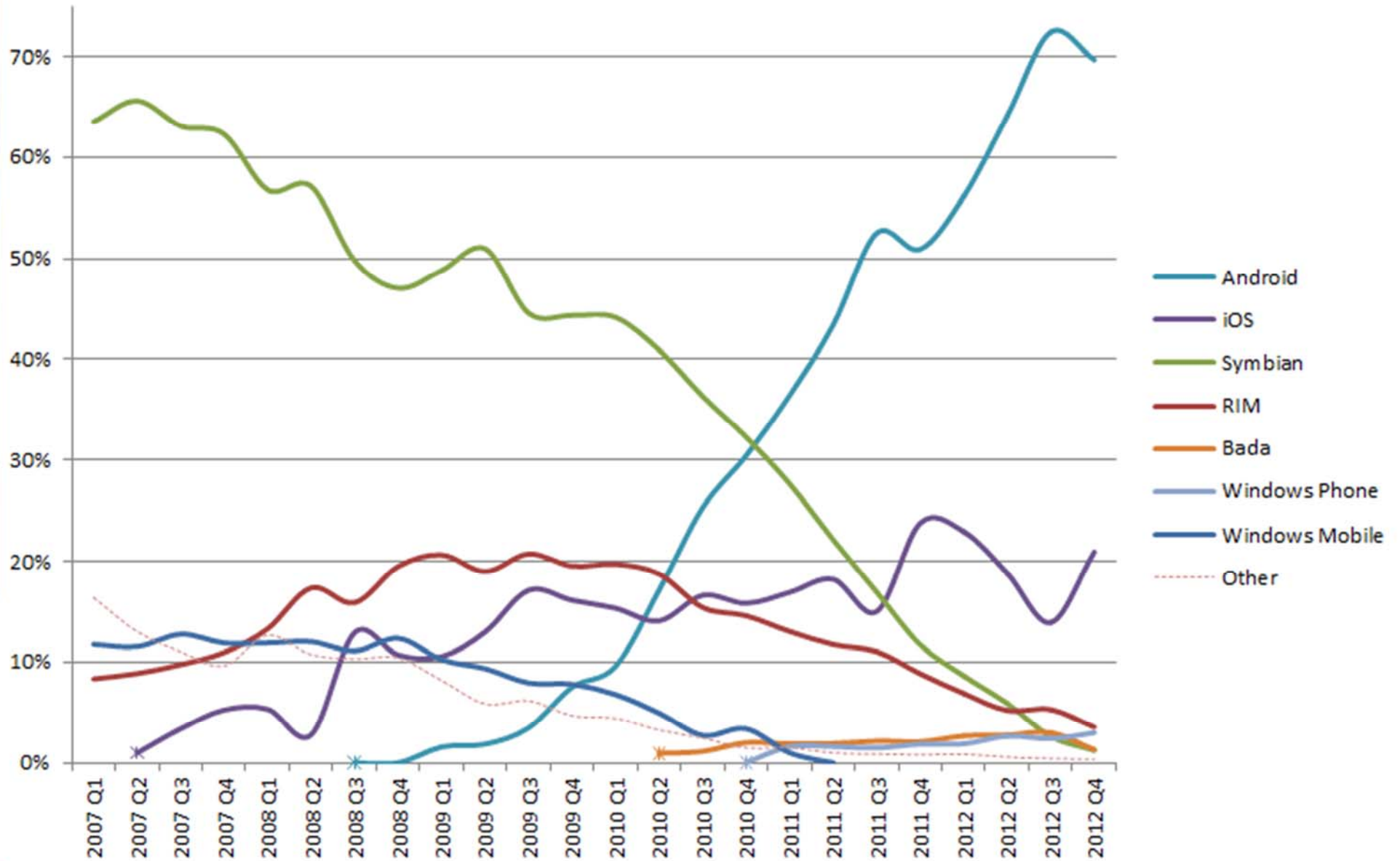



Worldwide Mobile Communications Device Open OS Sales to End Users by OS (Thousands of Units)

OS	2010	2011	2012	2015
Symbian	111,577	89,930	32,666	661
Market Share (%)	37.6	19.2	5.2	0.1
Android	67,225	179,873	310,088	539,318
Market Share (%)	22.7	38.5	49.2	48.8
Research In Motion	47,452	62,600	79,335	122,864
Market Share (%)	16.0	13.4	12.6	11.1
iOS	46,598	90,560	118,848	189,924
Market Share (%)	15.7	19.4	18.9	17.2
Microsoft	12,378	26,346	68,156	215,998
Market Share (%)	4.2	5.6	10.8	19.5
Other Operating Systems	11,417	18,392	21,383	36,133
Market Share (%)	3.8	3.9	3.4	3.3
Total Market	296,647	467,701	630,476	1,104,898

Source: Gartner (April 2011)

Sommario



Problematiche dei sistemi mobili

Confronti fra SO e modelli di sviluppo

Distribuzione di contenuti per sistemi mobili

Modello di Programmazione iPhone

♣ Si veda slide separate Parte 7a

Modello di Programmazione Android

Mobile Medicine

♣ Windows Mobile

♣ iPhone/iPad

♣ Android

Content Organizer

Mobile Emergency

Mobiles and Sensors



ITALIA DEGLI INNOVATORI

Agenzia per la Diffusione delle Tecnologie per l'Innovazione
Presidenza del Consiglio dei Ministri



ITALIA DEGLI INNOVATORI

Agenzia per la Diffusione delle Tecnologie per l'Innovazione
Presidenza del Consiglio dei Ministri



Mobile e problemi di Distribuzione

Distribuzione di contenuti multimediali su sistemi mobili

- ♣ Dispositivi eterogenei
- ♣ Protocolli/profilo di connessione molto diversi
- ♣ Codec contenuti e applicazioni nel mobile molto diverse, le licenze pesano molto e determinano il costo e il contenuto
- ♣ preferenze degli utenti sul formato

E' Sempre meno necessario adattare I contenuti on demand, MPEG-21 DIA

- ♣ Device capabilities: CCPP, Network capabilities, User preference, Context,...
- ♣ Etc..

Sempre piu' potenti mobile, possono interpretare:

- ♣ HTML complessi con JS e media diversi



Problemi di distribuzione contenuti

Streaming and/or progressive download

- ♣ RTSP

Formati media

- ♣ Video decoder diversi: H264, FLV, MPEG-4

- ♣ Audio decoder diversi: AAC, MP3

- ♣ Immagini: quasi tutti i formati

- ♣ PDF: non sempre supportato

- ♣ Flash: non sempre supportato

- ♣ eBook: dipende dal tipo....

- ♣

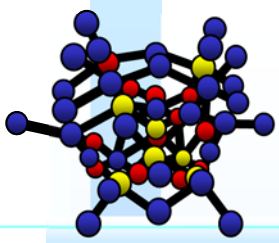

Production On Demand



RICHIAMO

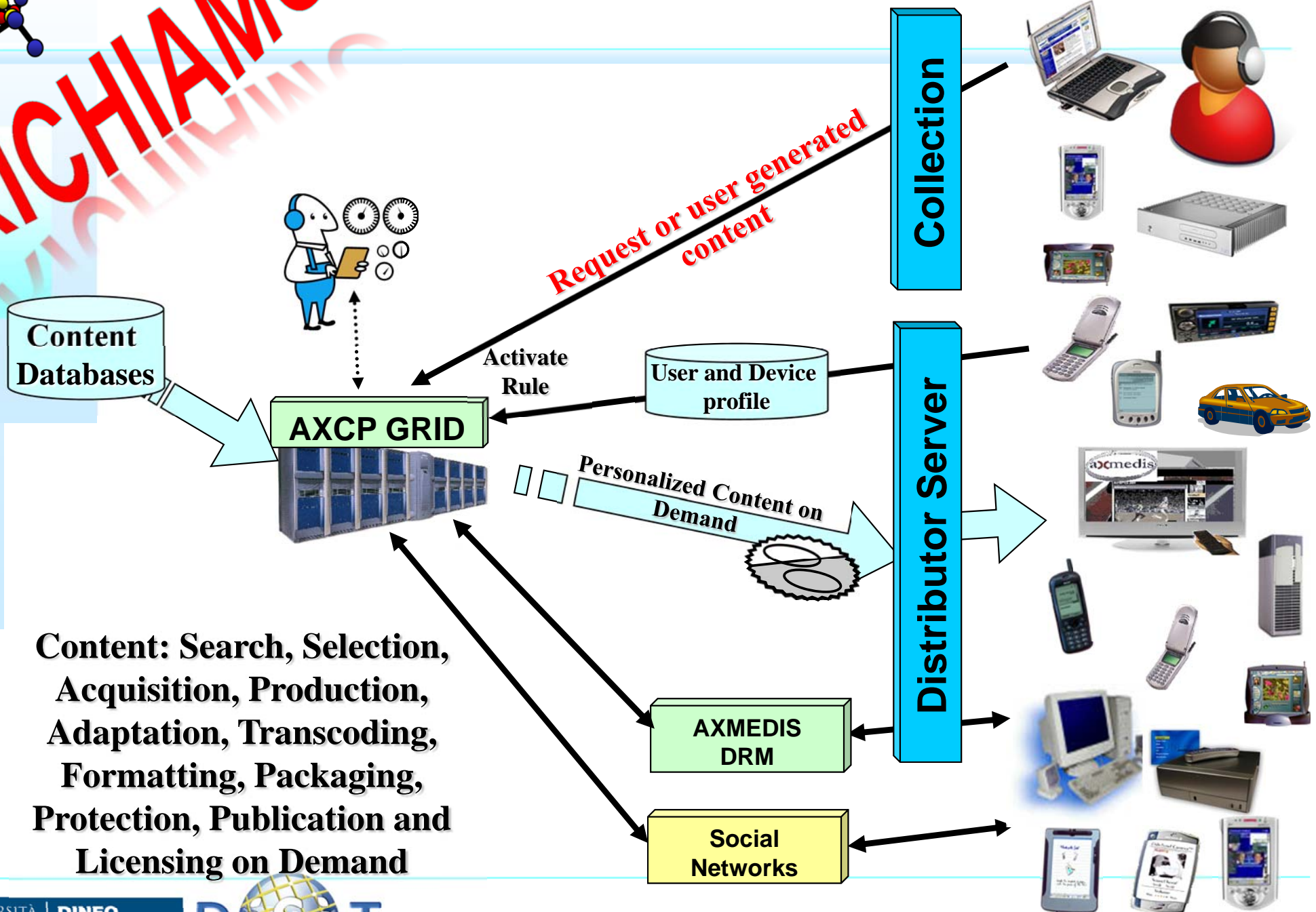

Content: Search, Selection, Acquisition, Production, Adaptation, Transcoding, Formatting, Packaging, Protection, Publication and Licensing on Demand

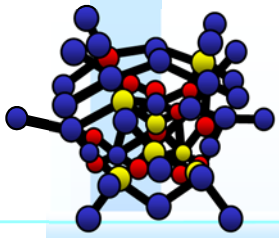

Aspetti rilevanti

- ❑ Device che comunicano al server il loro profilo (CCPP)
- ❑ Device che collezionano dati del profilo utente e che gli possono passare al server (CCPP)
- ❑ Server che devono essere in grado di leggere ed interpretare queste informazioni per adattare il loro servizio
- ❑ Server devono essere in grado di gestire un numero elevato di elaborazioni al minuto o al giorno
- ❑ Servizi off-line e/o realtime (online, on demand):
 - ♣ Generazione di pagine WEB dinamiche
 - ♣ Generazione di contenuti digitali adattati secondo le esigenze di utente, device, connessione



Sommario

- | Problematiche dei sistemi mobili
- | Confronti fra SO e modelli di sviluppo
- | Distribuzione di contenuti per sistemi mobili
- | Modello di Programmazione iPhone
 - ♣ Si veda slide separate Parte 7a
- | Modello di Programmazione Android
- | Mobile Medicine
 - ♣ Windows Mobile
 - ♣ iPhone/iPad
 - ♣ Android
- | Content Organizer
- | Mobile Emergency
- | Mobiles and Sensors

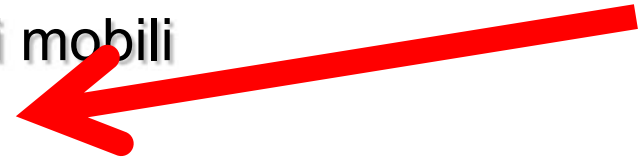

Programmazione con Eventi



Eventi dai driver:

- n- button
- n- onclick
- n- onmove
- n- sensor
- n- sms
- n- call
- n- redraw
- n- rx from network
- n Etc...

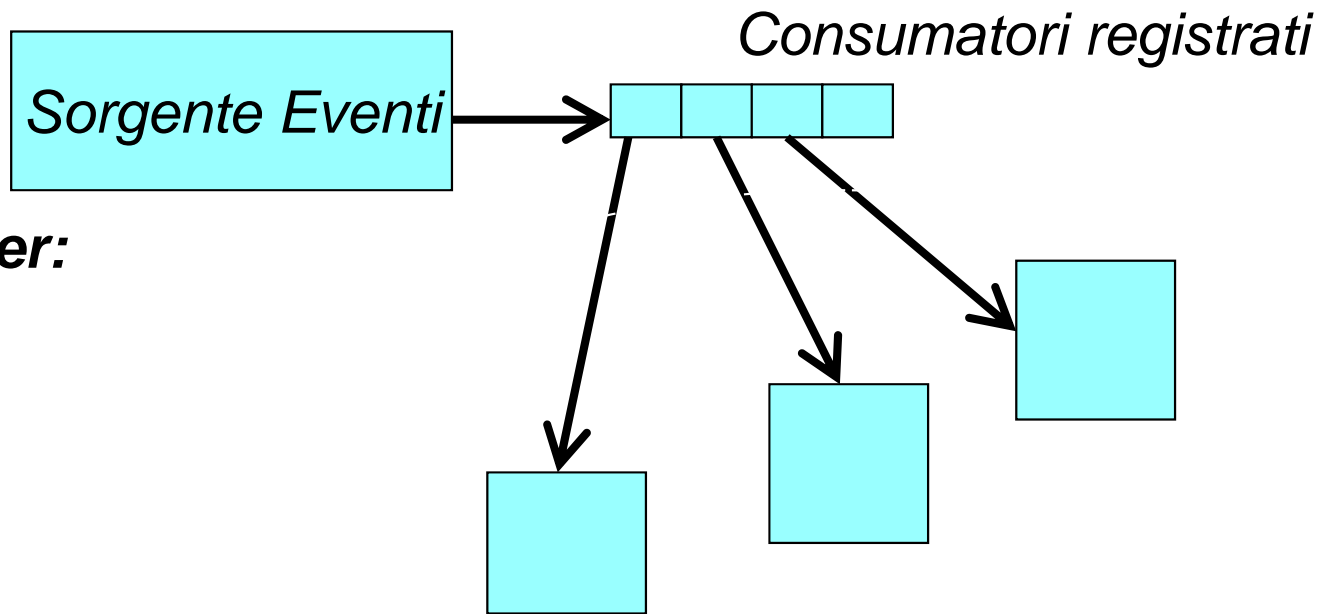

Listeners

(interfaccia richiesta dalla sorgente)
- → call Back!!



Modello di programmazione per iPhone

- | SDK: Development kit solo per Apple MAC
- | Accesso a tutte le features: accelerometri, GPS, multitouch, etc..
- | Visione ristretta delle risorse
- | Una sola applicazione running
- | Cocoa Foundation

```
#import <UIKit/UIKit.h> int main(int argc, char *argv[])  
{  
    NSAutoreleasePool * pool = [[NSAutoreleasePool alloc] init];  
    int retVal = UIApplicationMain(argc, argv, nil, nil); [pool release];  
    return retVal;  
}
```

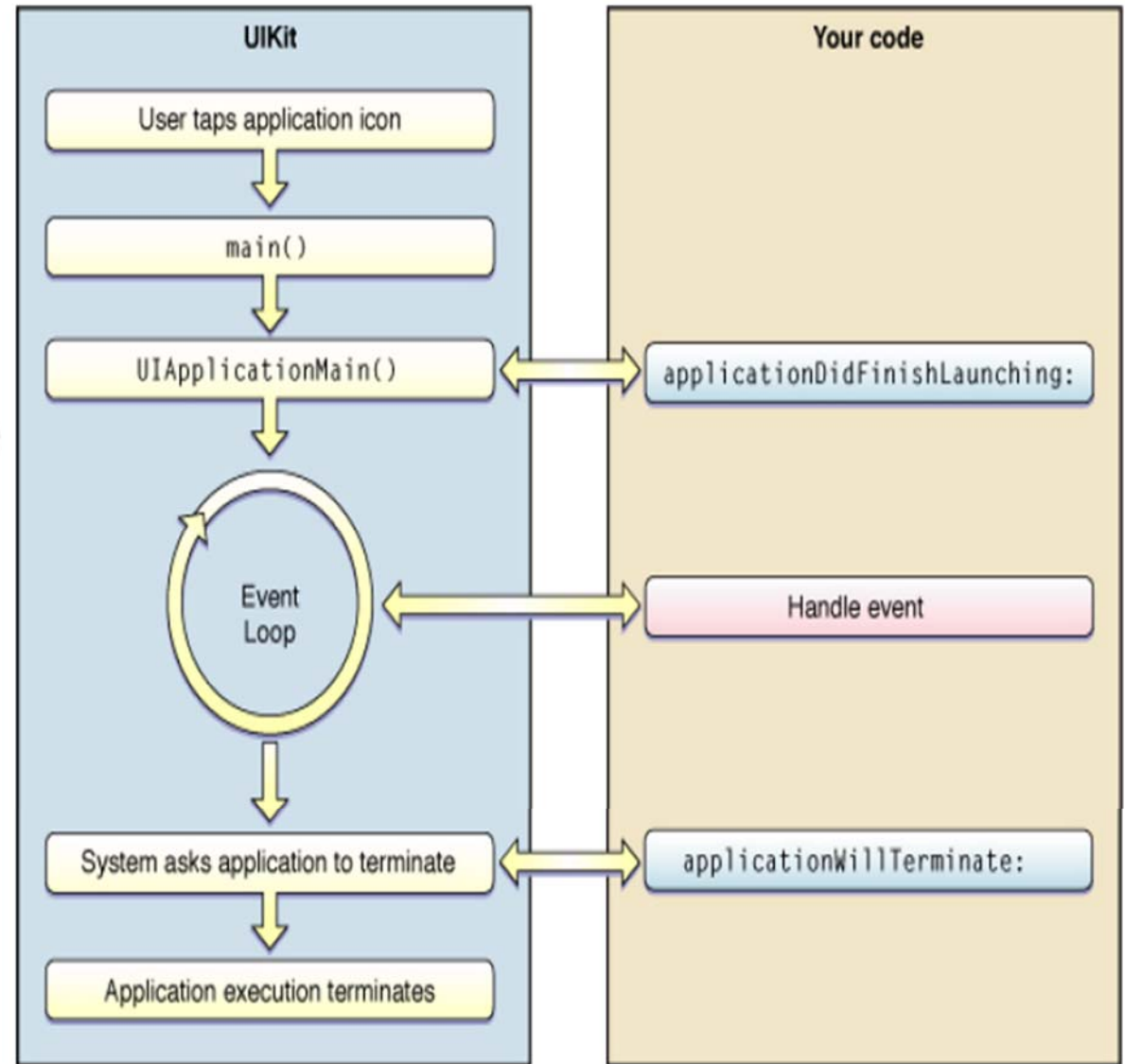



Gestione coda comandi, iPhone

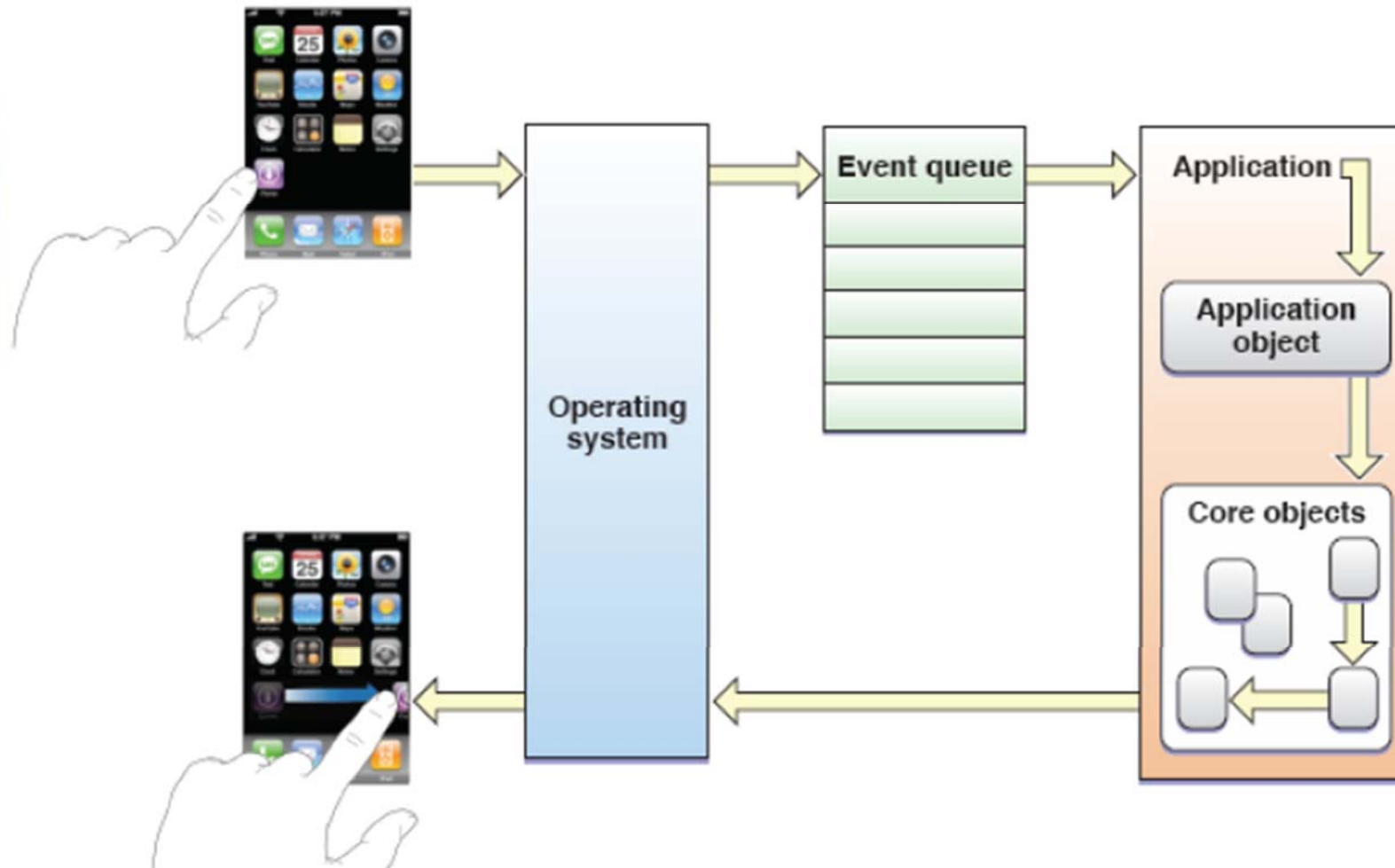



Gestione Richieste di interruzione , iPhone

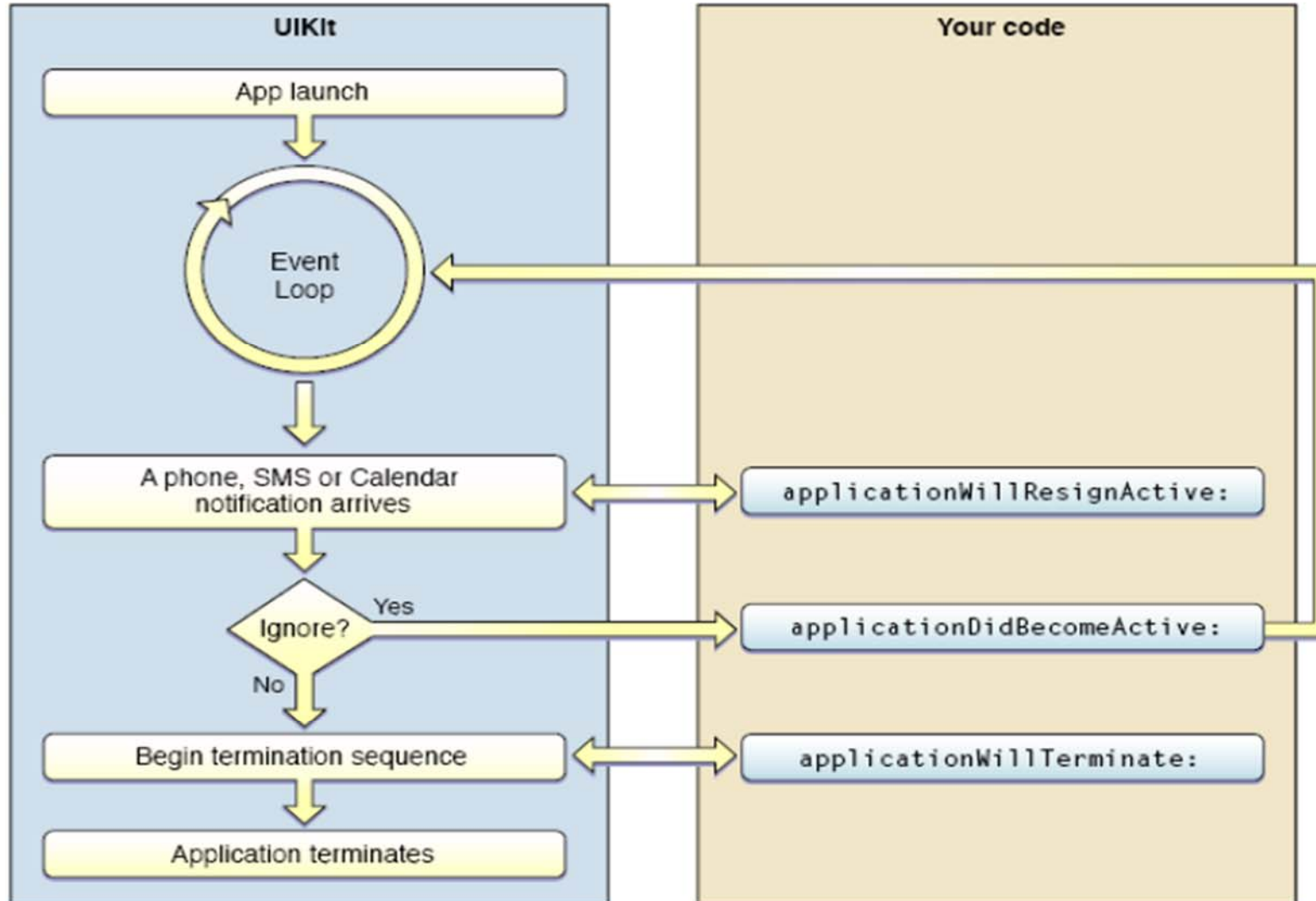

iPhone Programming: richiesta di interruzione



Modello di programmazione iPhone

- | **Dimensione dello schermo compatta**
- | **Memoria virtuale limitata**
- | **Sistema Single-Tasking:** una sola applicazione per volta. se l'utente lancia un'altra applicazione, e.g., rispondendo ad una chiamata, il processo corrente viene sospeso. Si devono salvare tutte le informazioni necessarie per un successivo riavvio in uno stato consistente con la sospensione.
- | **Manuale utente minimale:**
- | **tipi**
 - ♣ **iPhone application:**
 - ♣ **Web-only content:**
 - ♣ **Hybrid application:**



Modellazione dell'interfaccia utente con elementi e modello di interazione standard

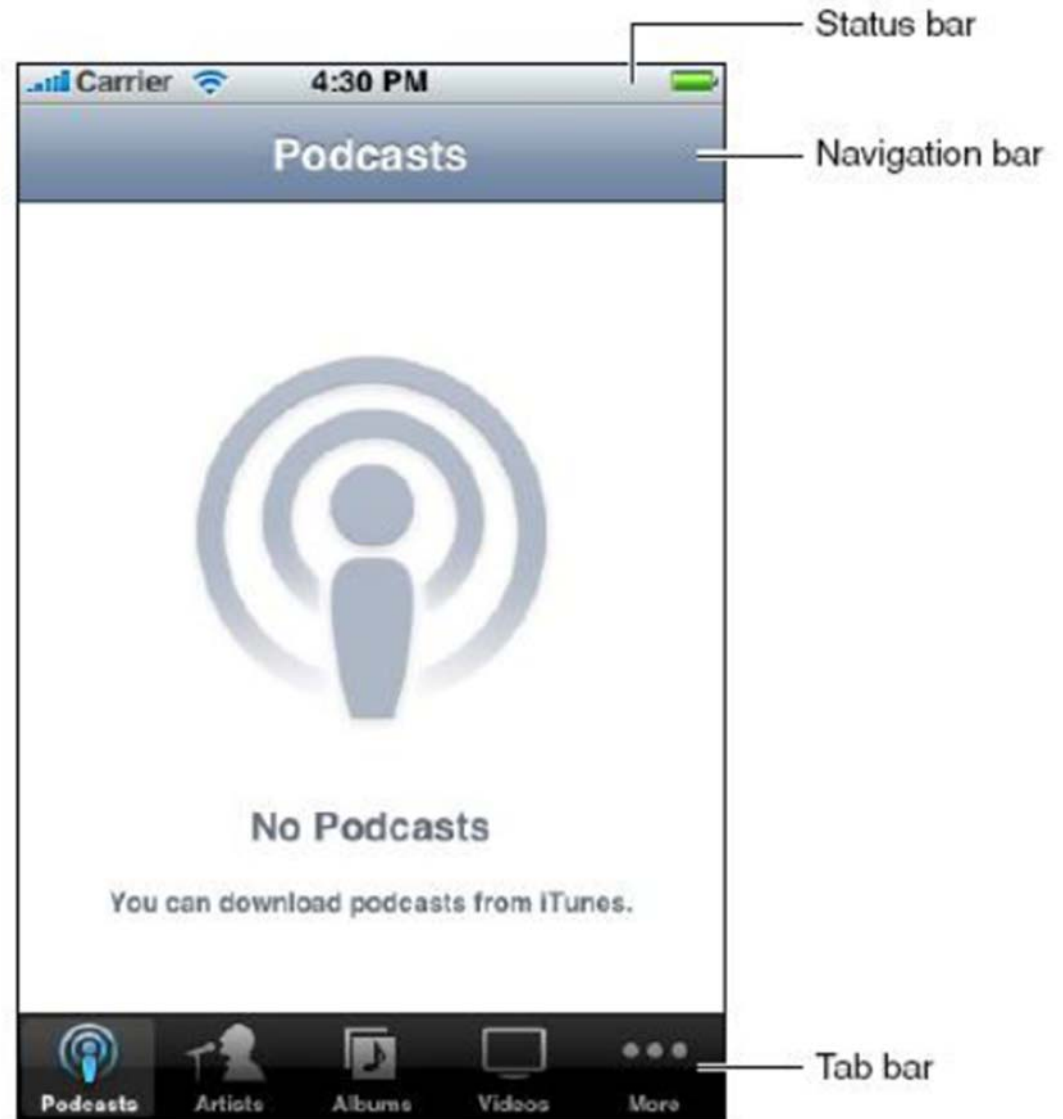



Pattern di progettazione, iPhone

Model view controller

- ♣ Demando il controllo
- ♣ Maggiore riuso
- ♣ Interfacce definite

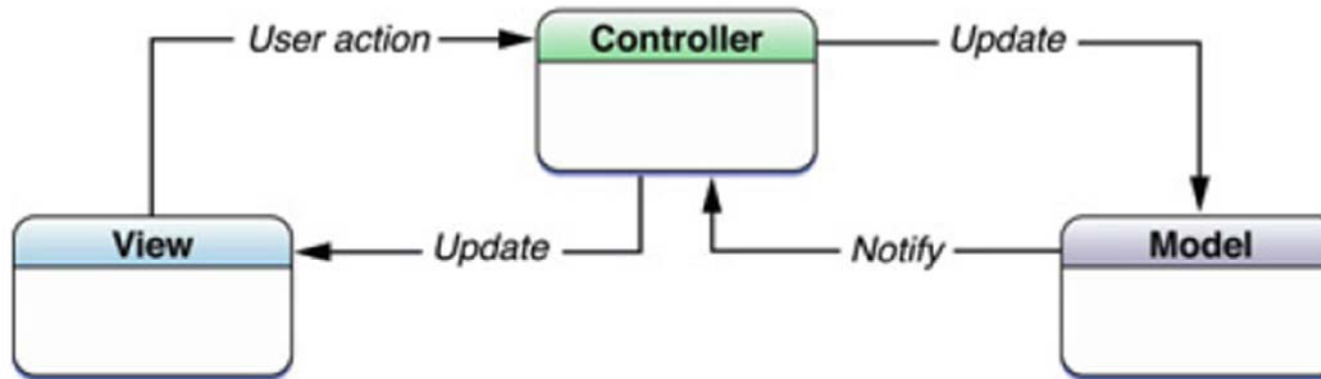

- Cocoa Design Pattern: MVC



Pattern Model View Control

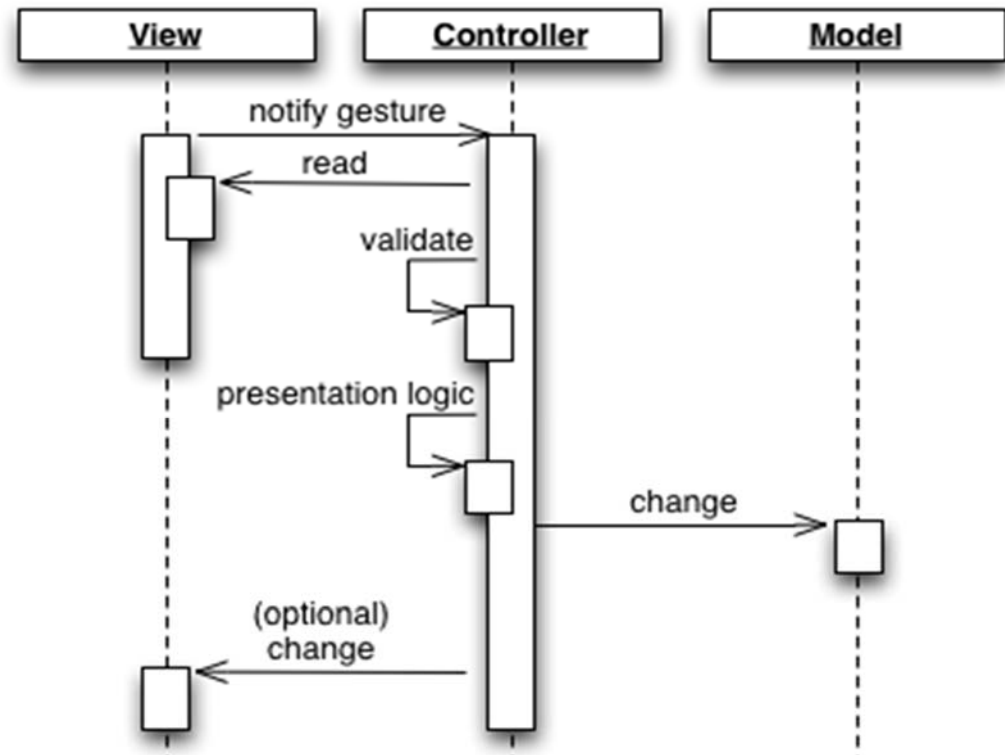
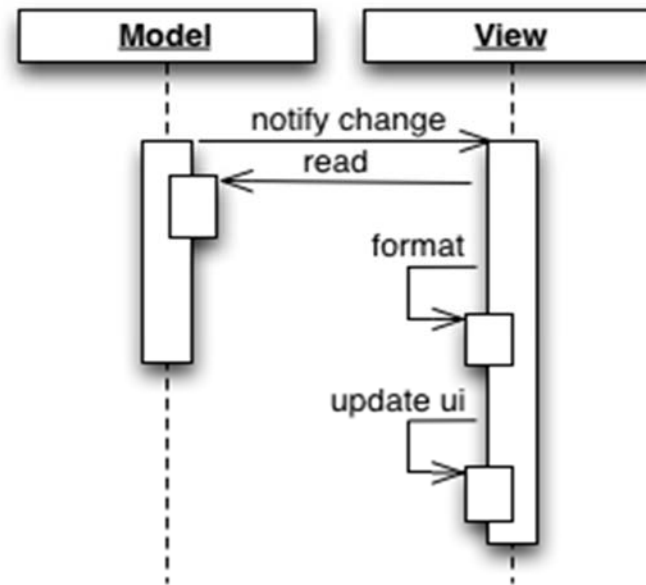



Pattern di progettazione, iPhone

Command Pattern

- ♣ encapsulate a request as an object, thereby letting you parameterize clients with different requests, queue or log requests, and support undoable operations
- ♣ Isola il codice che fa l'azione, dal codice che ne richiede l'esecuzione.

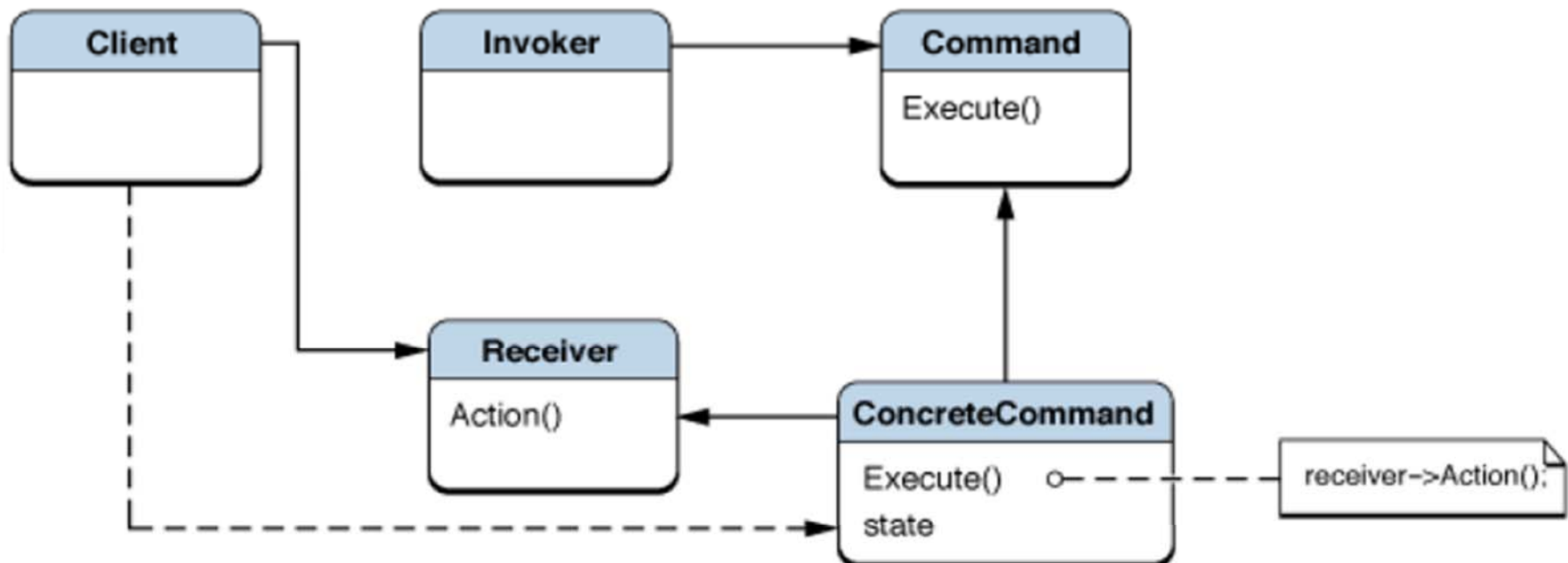

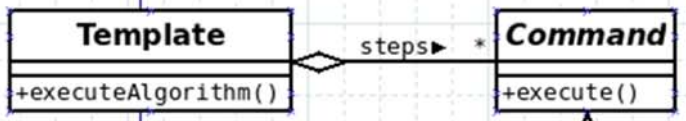
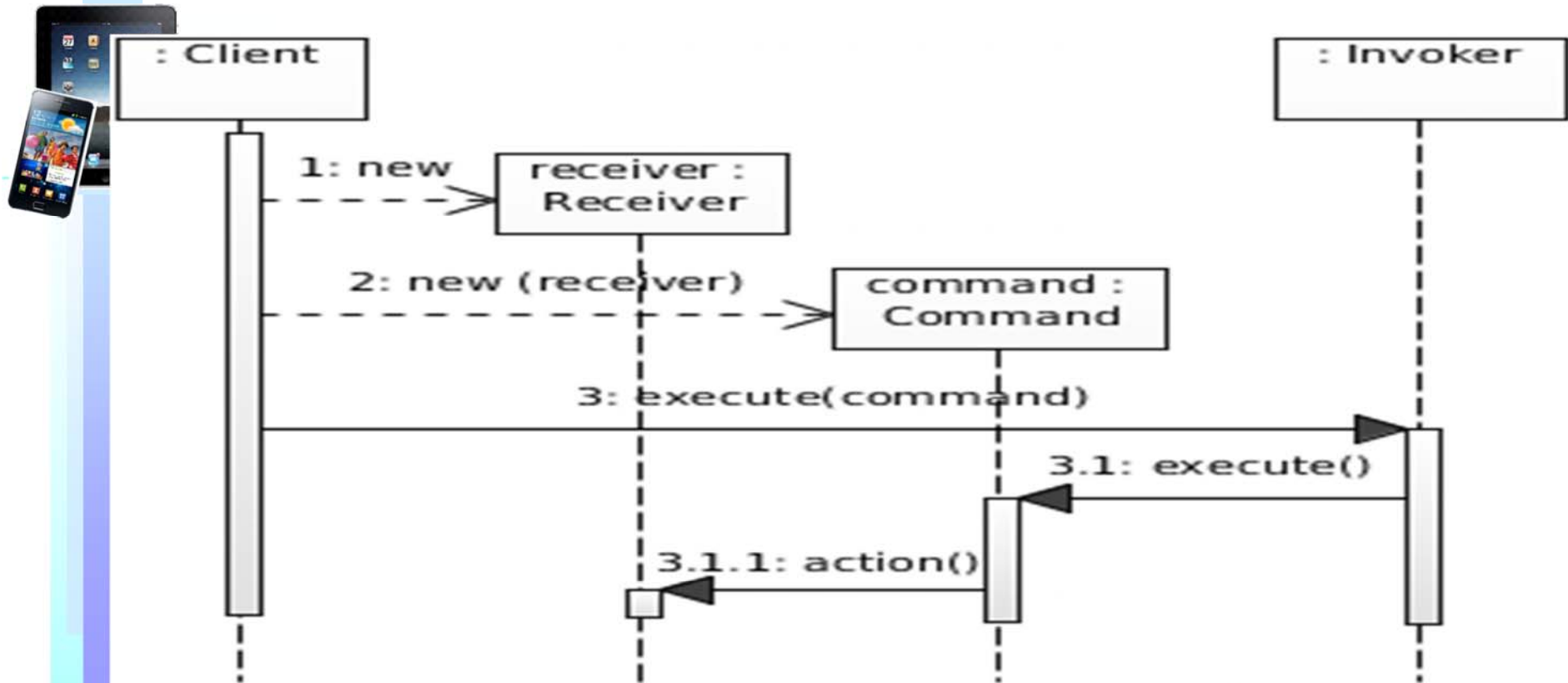

```

private List <Command> steps;
public final void executeAlgorithm(){
    for (Command individualStep : steps){
        individualStep.execute();
    }
}
  
```

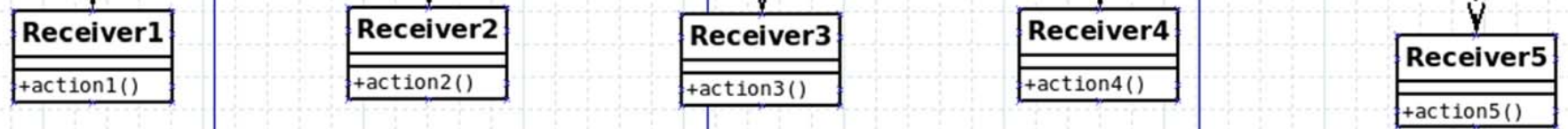
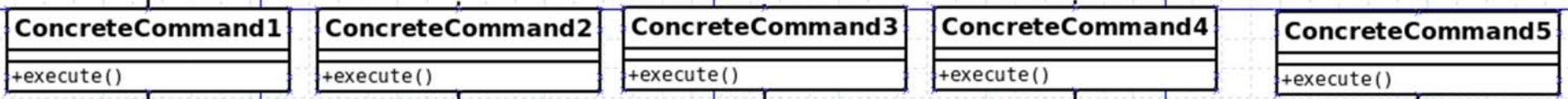

IDE: Sviluppo con XCODE



Build failed (9 errors)

Build failed (9 errors)

Build failed (9 errors)

Failed 9

```
27 // initialize controller classes before loading nib file by getting
28 // its objcClass property.
29 ApplicationController.objcClass;
30 AdderController.objcClass;
31
32 auto app = new UIApplication;
33 UIApplication.loadNib("Main.nib", app);
34 app.run();
35
36 return 0;
37 }
38
```

Apple Notifiche in Push

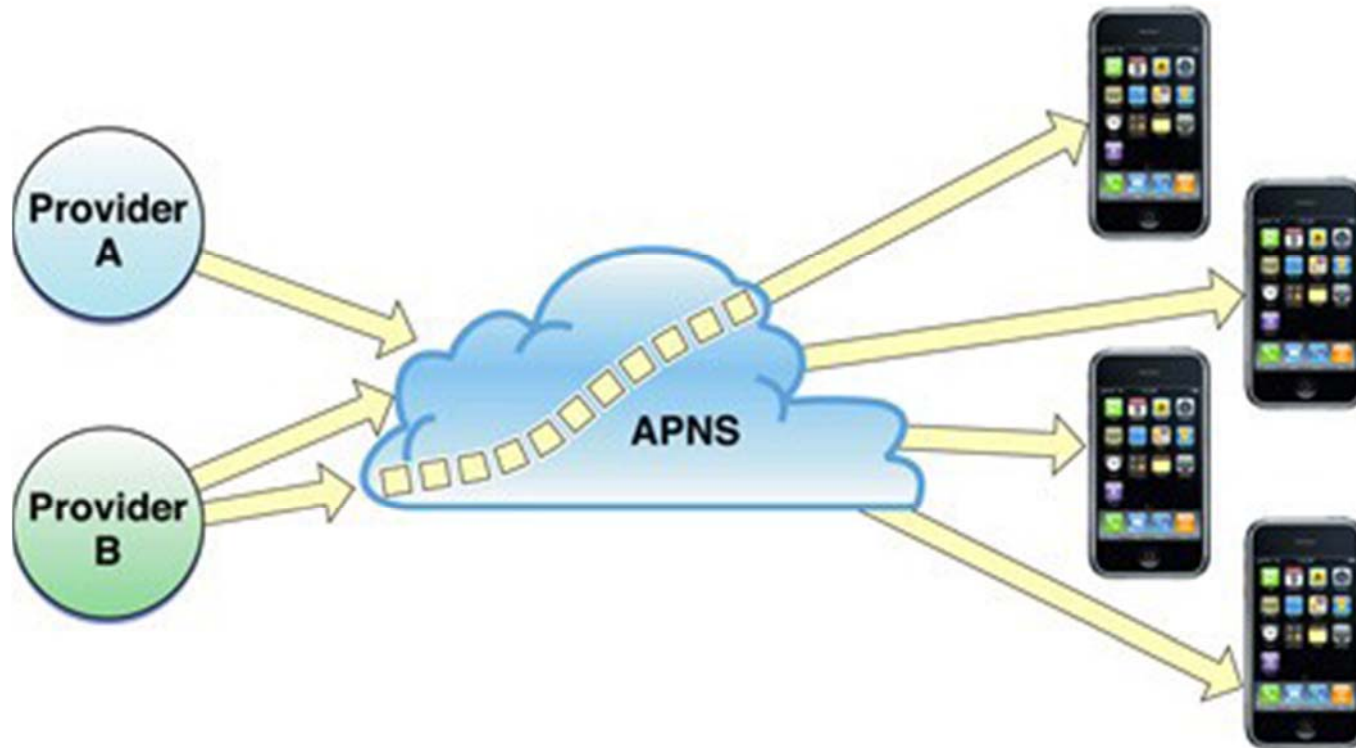

Notifiche in Push

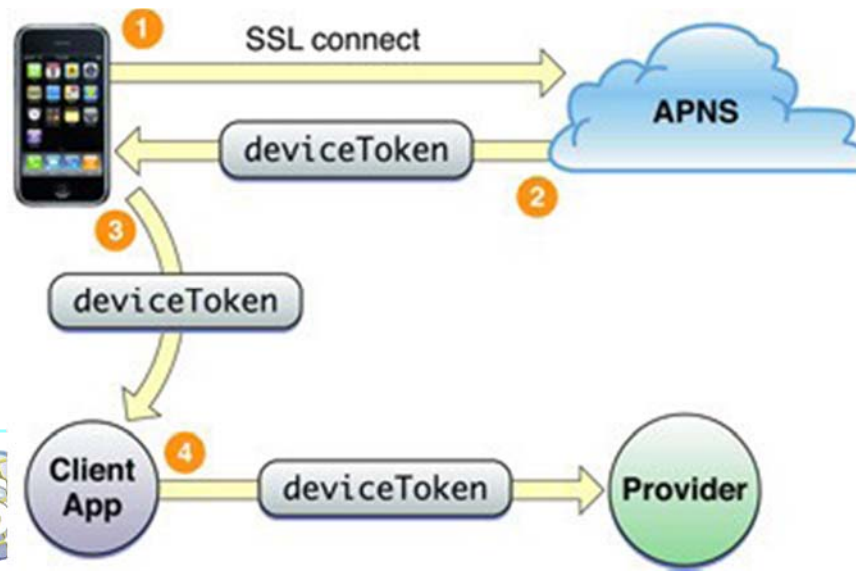
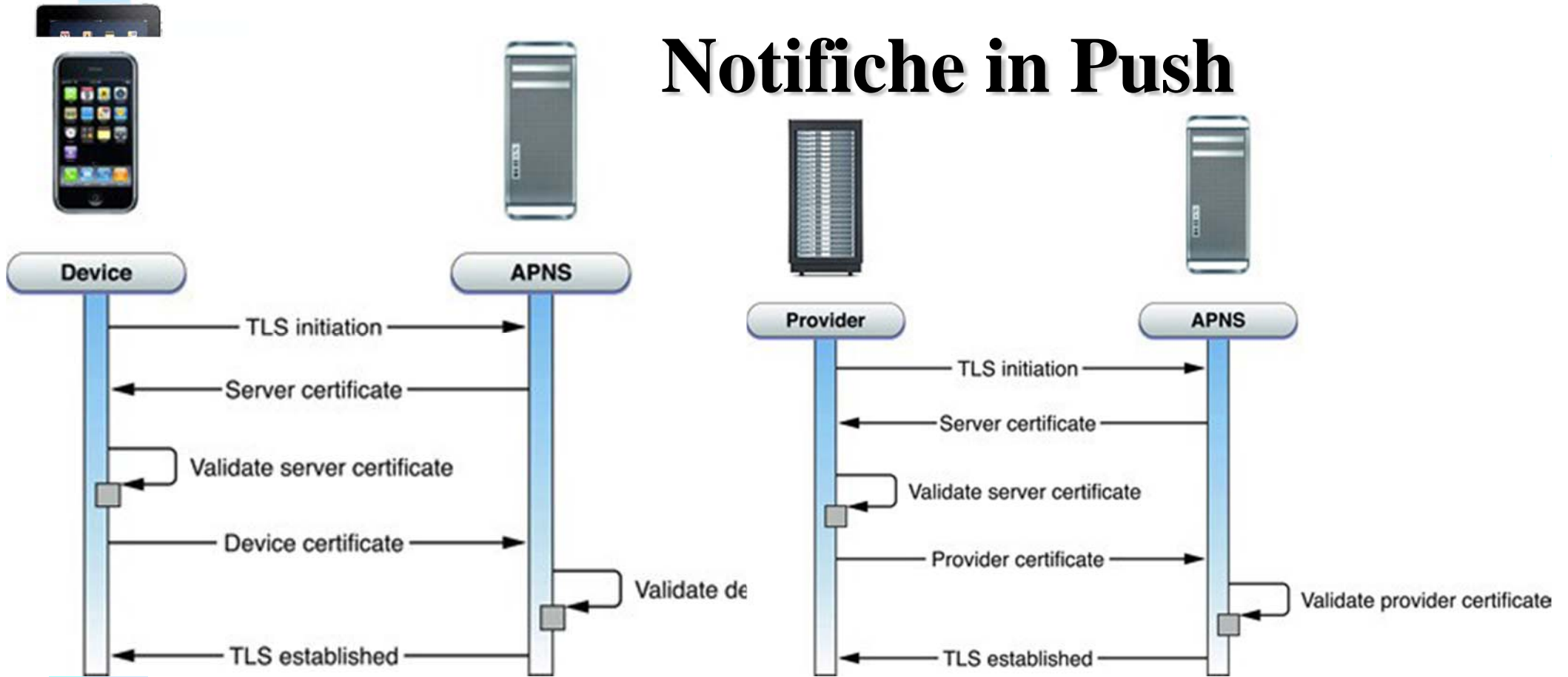

Sommario



- | Problematiche dei sistemi mobili
- | Confronti fra SO e modelli di sviluppo
- | Distribuzione di contenuti per sistemi mobili
- | Modello di Programmazione iPhone
 - ♣ Si veda slide separate Parte 7a
- | Modello di Programmazione Android
- | Mobile Medicine
 - ♣ Windows Mobile
 - ♣ iPhone/iPad
 - ♣ Android
- | Content Organizer
- | Mobile Emergency
- | Mobiles and Sensors

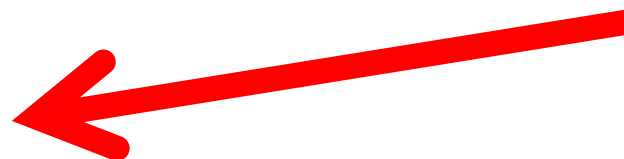

ITALIA DEGLI INNOVATORI
Agenzia per la Diffusione delle Tecnologie per l'Innovazione
Presidenza del Consiglio dei Ministri



ITALIA DEGLI INNOVATORI
Agenzia per la Diffusione delle Tecnologie per l'Innovazione
Presidenza del Consiglio dei Ministri



Architettura Android

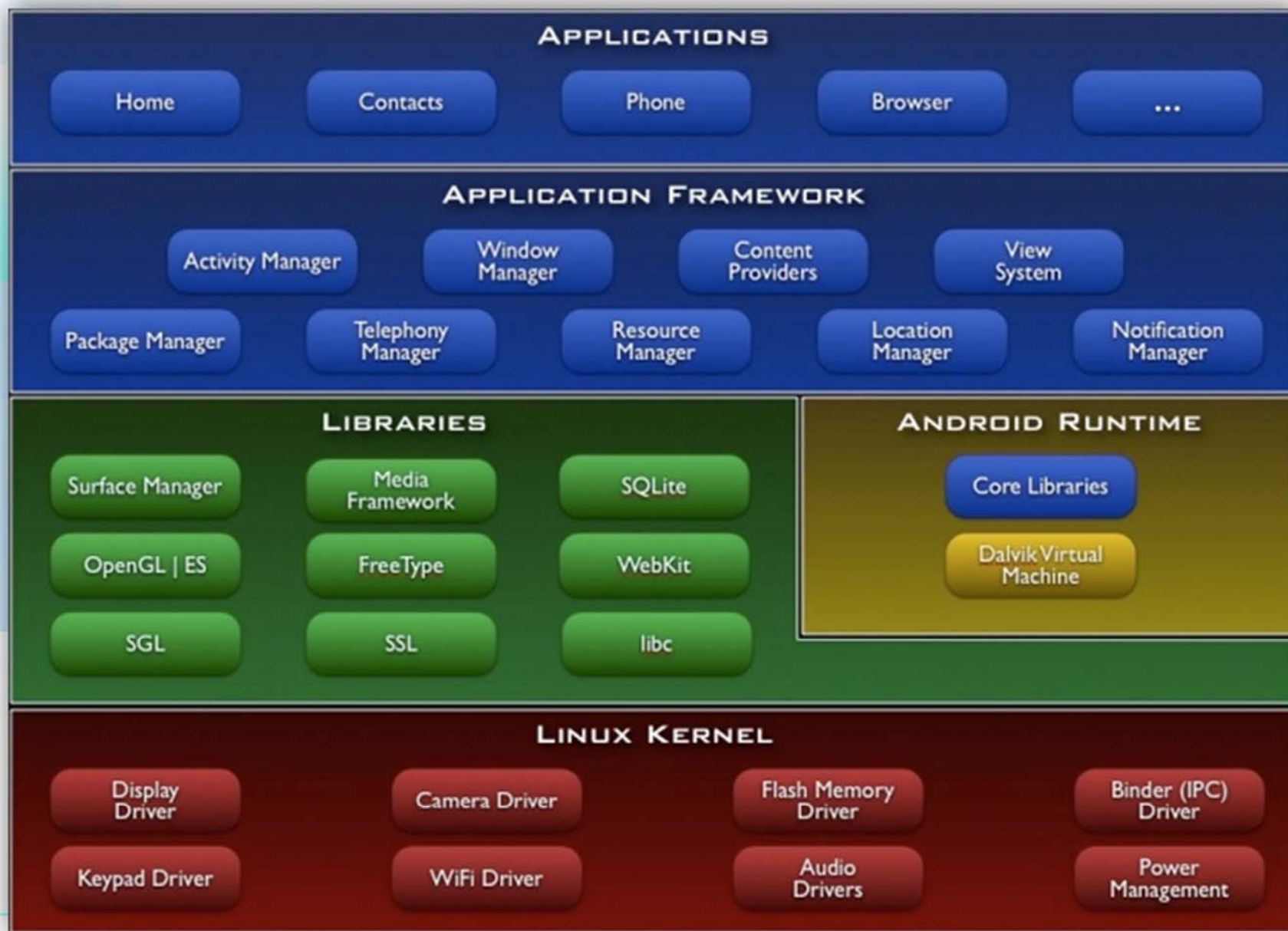

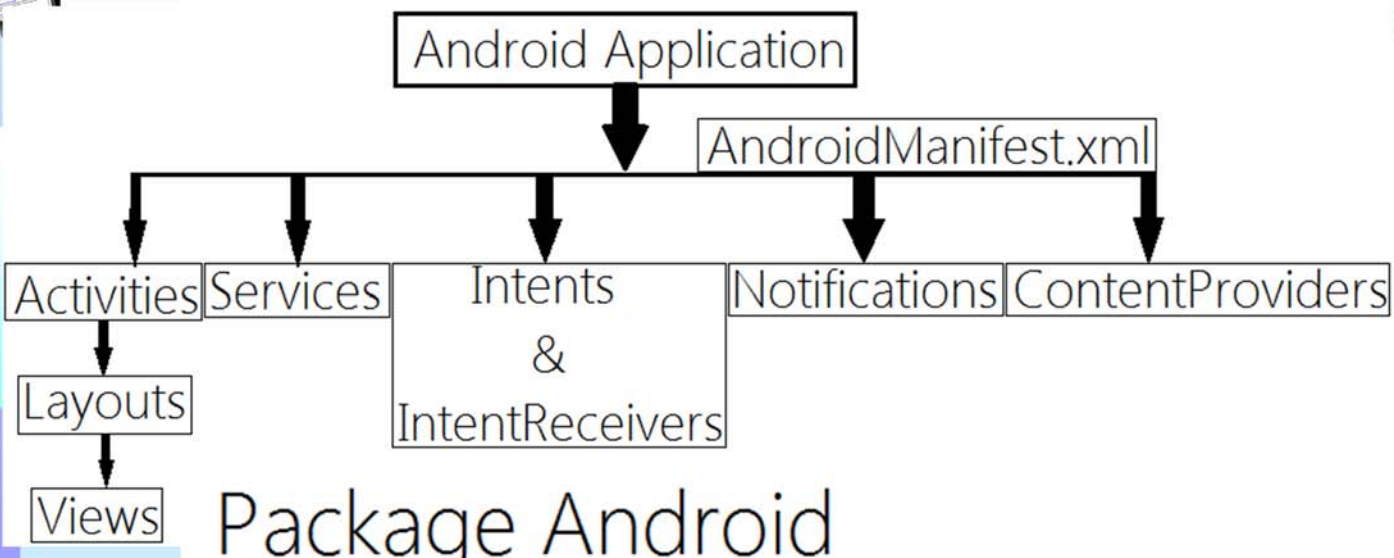

Package Android

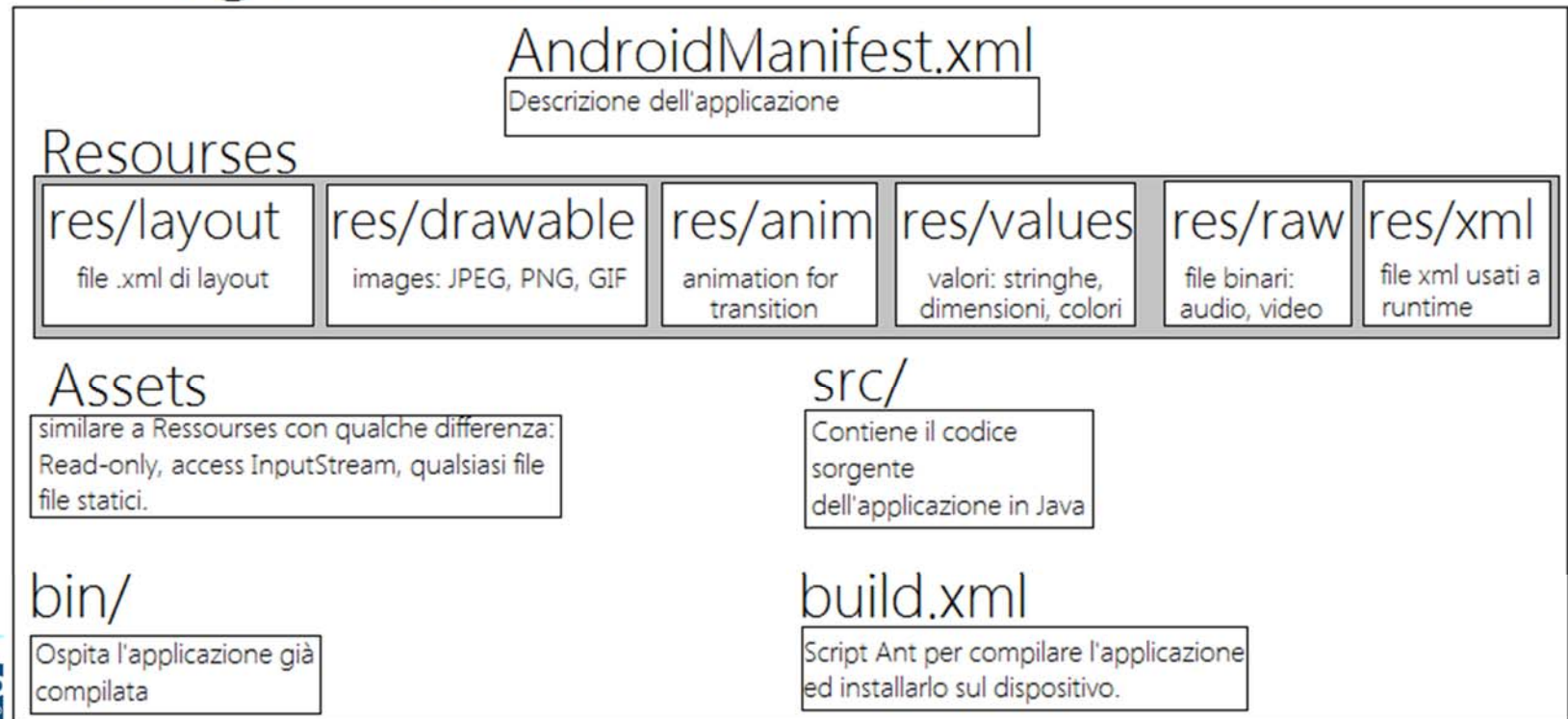



```
<?xml version="1.0" encoding="utf-8"?>
```

```
<LinearLayout xmlns:android="http://schemas.android.com/apk/res/android"
```

```
  android:orientation="vertical"
```

```
  android:layout_width="fill_parent"
```

```
  android:layout_height="fill_parent">
```

```
  <WebView android:id="@+id/Webkit"
```

```
    android:layout_width="fill_parent" android:layout_height="fill_parent"/>
```

```
</LinearLayout>
```

```
public class BrowserDemo1 extends Activity {
```

```
  WebView browser;
```

```
  @Override
```

```
  public void onCreate(Bundle savedInstanceState) {
```

```
    super.onCreate(savedInstanceState);
```

```
    setContentView(R.layout.main);
```

```
    browser=(WebView)findViewById(R.id.Webkit);
```

```
    browser.loadUrl("http://mobmed.axmedis.org");
```

```
  }
```

```
}
```

Hello WEB





Sommario

- | Problematiche dei sistemi mobili
- | Confronti fra SO e modelli di sviluppo
- | Distribuzione di contenuti per sistemi mobili
- | Modello di Programmazione iPhone
 - ♣ Si veda slide separate Parte 7a
- | Modello di Programmazione Android
- | Mobile Medicine
 - ♣ Windows Mobile
 - ♣ iPhone/iPad
 - ♣ Android
- | Content Organizer
- | Mobile Emergency
- | Mobiles and Sensors



Portale: Mobile Medicine



Back office
automatico



Contenuti
professionali

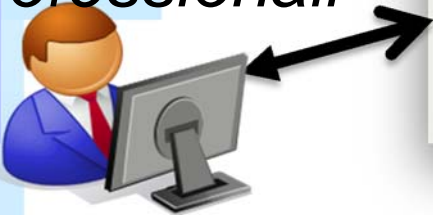

UGC, web
page, commenti

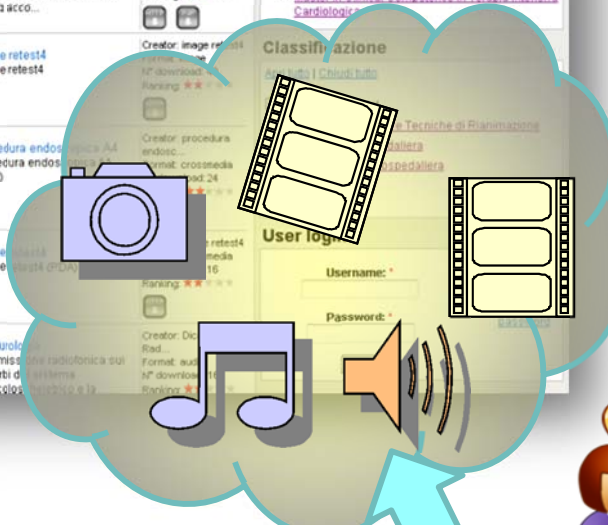

ITALIA DEGLI INNOVATORI

Agenzia per la Diffusione delle Tecnologie per l'Innovazione
Presidenza del Consiglio dei Ministri

-PC, MACOs, linux,
...
-iPhone, iPod,
Windows Mobile,
Android





n Automated
n Back office



n ANY content



n ANY content

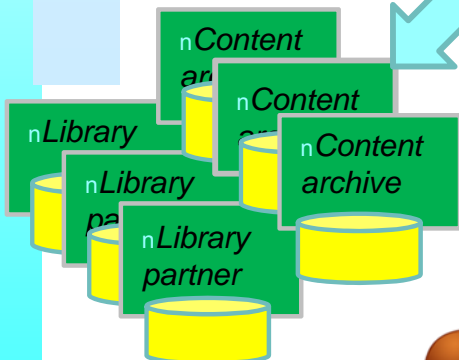

n UGC, web page,
comments

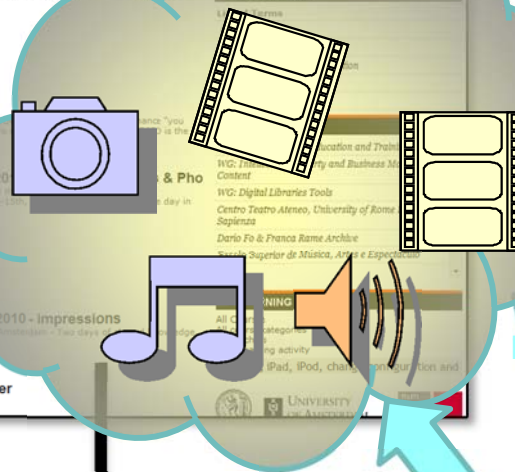

n -PC, MACos, linux,
...

n -iPhone, iPod,
Windows Mobile,
.....

n Search/Query



n Agg. Content Service

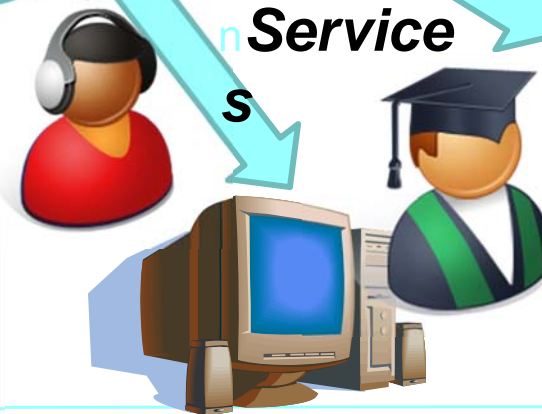

n Metadata





Le Tecnologie (1/2)

Semantica e suo processing (Web 3.0):

- ♣ **Oggetti intelligenti**, interattivi e proattivi, classificazione: descrittori e tassonomie
- ♣ **Profili** delle persone, gruppi, contenuti etc.
 - Ricerche contenuti e persone/esperienze
- ♣ **Tracciamento** del comportamento dinamico degli utenti: azioni/interessi, play, download, etc.
- ♣ **Raccomandazioni** sulla base delle *similitudini*:
 - UserUser, ObjUser, ObjObj, etc.
 - Valutazione di aspetti statici e dinamici
- ♣ **Organizzazione** di oggetti e raccomandazioni pers.
 - lato server: tramite il portale, per PC, iPhone, iPod,...
 - sul Mobile (solo WM al momento): applicazione MobileMedicine su Windows Mobile



Contenuti Digitali Complessi

File e/o mini applicazioni

- ♣ file singoli con:

 - video, immagini, documenti, audio, animazioni, ...

- ♣ **Mini applicazioni, collezioni, form,**:

 - procedure, calcolatori, liste di controllo, flussi, ...

 - lezioni, interattività, form/liste di controllo, etc...

- ♣ **+ metadati estesi**: Dublin Core + info sulla produzione, distribuzione, etc. Codici multipli di identificazione

- ♣ **+ classificazione tassonomica**: medica, tecnica, etc..

- ♣ **+ descrittori**, e molte altre informazioni

Esempi: accessibili dal portale e nell'installazione del

Player per PDA: <http://mobmed.axmedis.org/pda/pdaplayer.html>

Contenuti Digitali Complessi



AXPDAPlayer (versione mobile draft non validata numero 0.1)
18/3/2009, Rev. 0

Dipartimento del Cuore e dei Vasi
Dir. Prof. G.F. Gensini
Terapia Intensiva Cardiologica
Medico-Chirurgo
Dott. ssa S. Valente, Lazzeri, Dott. A

Farmaco: Abciximab
Nome commerciale: ReoPro

Protocolli farmaceutici
Calcolo dosaggio del ReoPro in bolo (in ml)
Abciximab (ReoPro) Dose 0,25 mg / kg
Fiale non diluite (fiale da 10 mg in 5 ml)

Tirofiban (Aggr IIa)
Eptifibatide (Integrin)
Levosimendan (S101)

Bicarbonato di sodio (Bicarbocid)
sodio)

File

AXPDAPlayer

Farmaco: Abciximab
Nome commerciale: ReoPro

Protocolli farmaceutici
Calcolo dosaggio del ReoPro in bolo (in ml)
Abciximab (ReoPro) Dose 0,25 mg / kg
Fiale non diluite (fiale da 10 mg in 5 ml)

Tirofiban (Aggr IIa)
Eptifibatide (Integrin)
Levosimendan (S101)

Bicarbonato di sodio (Bicarbocid)
sodio)

File

procedure

AXPDAPlayer

Con una mano sulla fronte inclinare la testa all'indietro. Con le due dita sotto il mento sollevare la mandibola con la

DOC

Adobe Reader LE

CONTROPULSAZIONE INTRA-AORTICA

IN TERAPIA INTENSIVA

Modalità di gestione dello IABP in UTIC

Strumenti Menu

AXPDAPlayer

"Contropulsazione intra-aortica in US: risultati del Registro Ben...

Mortalità intra-ospedaliera da tutte le cause

- 10,8% US
- 18% non-US

Complicanze correlate ad IABP

Mortalità legata ad IABP

- 0,05% US
- 0,07% non-US

Ischemia maggiore dell'arto

- 0,9% US
- 0,8% non-US

Emorragie gravi

- 0,9% US
- 0,8% non-US

La frequenza di complicanze correlate ad IABP è bassa ma nei centri US che non non-US

View File

video

AXPDAPlayer

GNR

GIORGIO DI CENTA
Gold

View File

AXPDAPlayer

Calcolo GFR (Cockcroft-Gault)

età 56

peso (Kg)

creatinina serica

donna?

Calcola

GFR = ?

File View

Calcolatori



AXPDAPlayer

Classificazione Neurologica Standard dei Traumi Midollari

MOTORIO: MUSCOLI CHIAVE

Inserire un valore da 0 a 5 oppure lasciare la cella vuota se non valutabile.

0 = paralisi totale
1 = contrazione palpabile o visibile
2 = movimento in assenza di resistenza
3 = movimento con gravità
4 = movimento contro parzial resistenza
5 = movimento con forza normale

Cella vuota = Not Testable (Non valutabile)

	D	S	
C5			Fless gomiti
C6			...

File

checklist

AXPDAPlayer

SENSITIVO: PUNTI SENSITIVI CHIAVE (3/3)

	Sensibilità Tattile Superficiale	Sensibilità Dolorifica		
	D	S	D	S
L1				
L2				

File View

AXPDAPlayer

(versione draft, non approvata/validata) DAI DEA e Medicina e Chirurgia Generale e di Urgenza

SOD Osservazione Breve Intensiva

Scegli un farmaco!

- ADRENALINA
- AMIODARONE
- DILTIAZEM (DILZEM)
- DOBUTAMINA (DOPAMINA (RELEVAN))
- DOPAMINA (RELEVAN)
- EPARINA
- ISOSORBIDE DINITRATO

File

dosaggi

AXPDAPlayer

Adrenalina: fiale 1mg/1ml

Diluizione: 10-47 ml di SF o G5 (1ml=40mcg)

Dosaggio: fiale: 1-2 mcg/min=1-2 ml/h

P. volumetrica
Diluizione: 1f in 250 ml di SF o G5 (1ml=4mcg)
Dosaggio iniziale: 1-2 mcg/min=15/30 ml/h

File View



Uno sguardo dietro e dentro

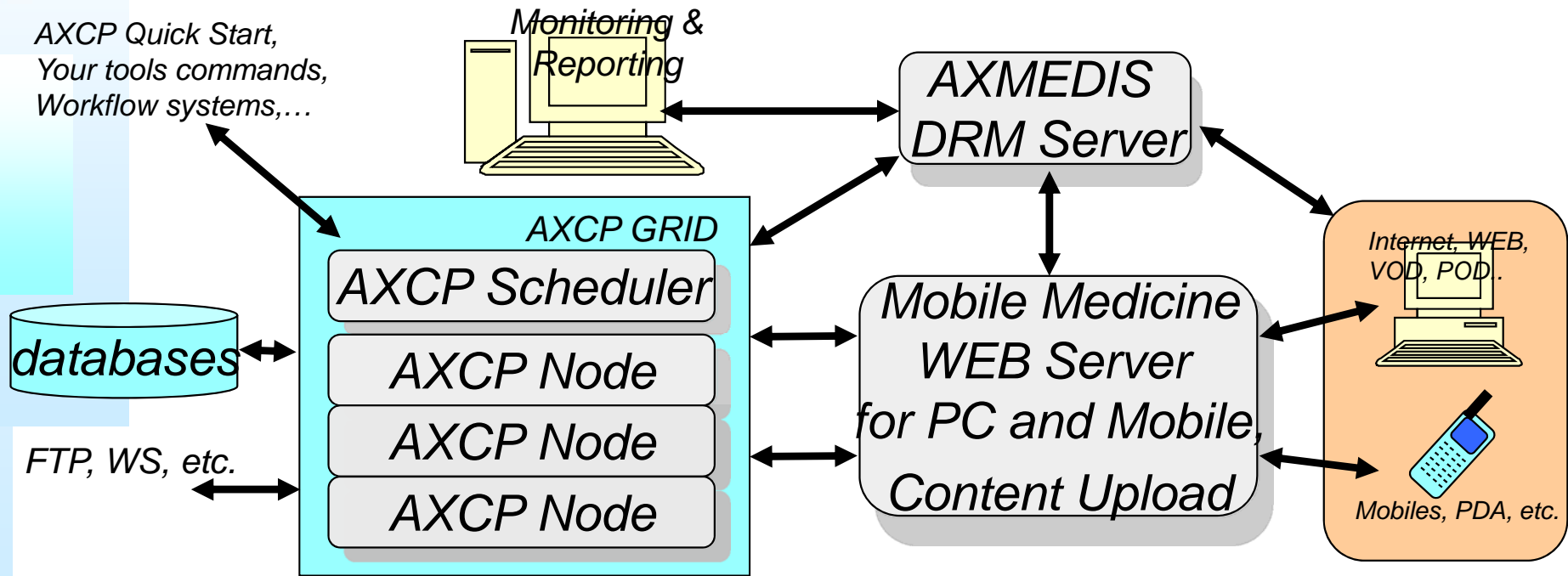

AXMEDIS AXCP GRID backoffice server

AXMEDIS DRM: per la gestione dei diritti e la sicurezza

XMF portal per la distribuzione multicanale:

- ♣ PC, PDA, iPhone, iPod, mobile, etc.

Strumenti di produzione e player per PC e PDA



Sommario

- | Problematiche dei sistemi mobili
- | Confronti fra SO e modelli di sviluppo
- | Distribuzione di contenuti per sistemi mobili
- | Modello di Programmazione iPhone
 - ♣ Si veda slide separate Parte 7a
- | Modello di Programmazione Android
- | Mobile Medicine
 - ♣ Windows Mobile
 - ♣ iPhone/iPad
 - ♣ Android
- | Content Organizer
- | Mobile Emergency
- | Mobiles and Sensors

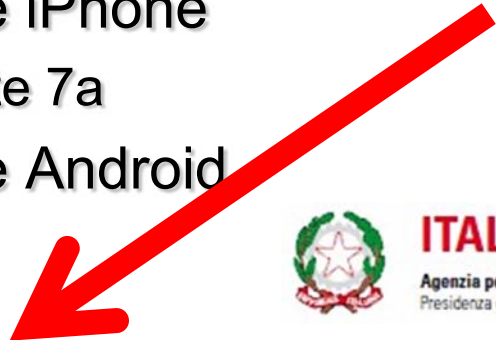

ITALIA DEGLI INNOVATORI
Agenzia per la Diffusione delle Tecnologie per l'Innovazione
Presidenza del Consiglio dei Ministri



ITALIA DEGLI INNOVATORI
Agenzia per la Diffusione delle Tecnologie per l'Innovazione
Presidenza del Consiglio dei Ministri



Windows Mobile vs Pocket PC, PDA



	Pocket PC 2000	Pocket PC 2002	Windows Mobile 2003	Windows Mobile 2003 SE	Windows Mobile 5.0	Windows Mobile 6	Windows Mobile 6.1	Windows Mobile 6.5
Pocket PC (Without Mobile Phone)	Pocket PC 2000	Pocket PC 2002	Windows Mobile 2003 for Pocket PC	N/A	Windows Mobile 5.0 for Pocket PC	Windows Mobile 6 Classic	Windows Mobile 6.1 Classic	N/A
Pocket PC (With Mobile Phone)	Pocket PC 2000 Phone Edition	Pocket PC 2002 Phone Edition	Windows Mobile 2003 for Pocket PC Phone Edition	Windows Mobile 2003 SE for Pocket PC Phone Edition	Windows Mobile 5.0 for Pocket PC Phone Edition	Windows Mobile 6 Professional	Windows Mobile 6.1 Professional	Windows Mobile 6.5 Professional
Smartphone (Without Touch Screen)	N/A	Smartphone 2002	Windows Mobile 2003 for Smartphone	Windows Mobile 2003 SE for Smartphone	Windows Mobile 5.0 for Smartphone	Windows Mobile 6 Standard	Windows Mobile 6.1 Standard	Windows Mobile 6.5 Standard



Software Development on Win Mobile



- | Java virtual machines are not powerfull
- | Development in
 - ♣ Visual C++ or
 - ♣ .Net Compact Framework, a subset of .Net, see Windows Phone SDK that work with Visual Studio development environment
- | Programming model
 - ♣ Similar to classical PC windows applications
 - ♣ Call back, API and multitasking, registry, full acess at the PDA resources, etc.
 - ♣ Deploy with CAB files, accessing to registry, etc.
- | Windows Mobile version 7
 - ♣ Is going to radically change the model, moving towards a model similar to iPhone

Portale e Organizer per PDA



Mobile Medicine



PDA
IE browser

Oggetti/Applicazioni

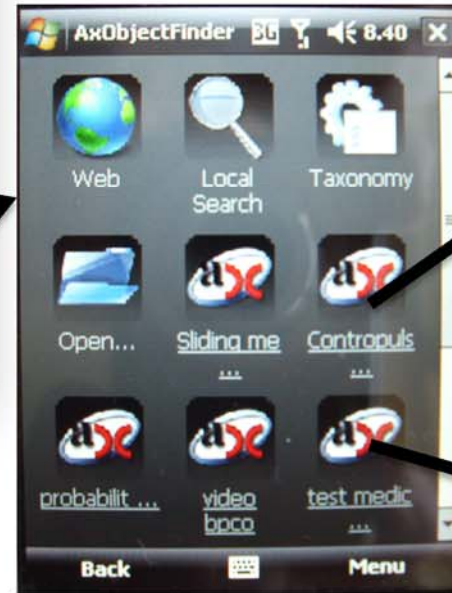

Mobile Medicine
Organiser

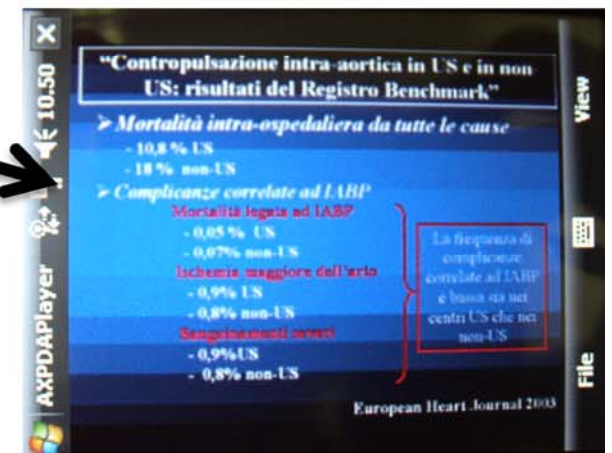

Accesso OFFLINE

Organiser per Windows Mobile



Suggerimenti Sulla base del comportamento dell'utente

Statistic	Value
Number of mp21 files in db	140
Number of terms in taxonomy	376
Number of scans completed	0
Files analysed	606
Dirs analysed	47
MP21 files analysed	144
New MP21 files added	1
New media files added	0
Files deleted	0
Bad MP21 files found	5

Personal Mobile Social Intelligence

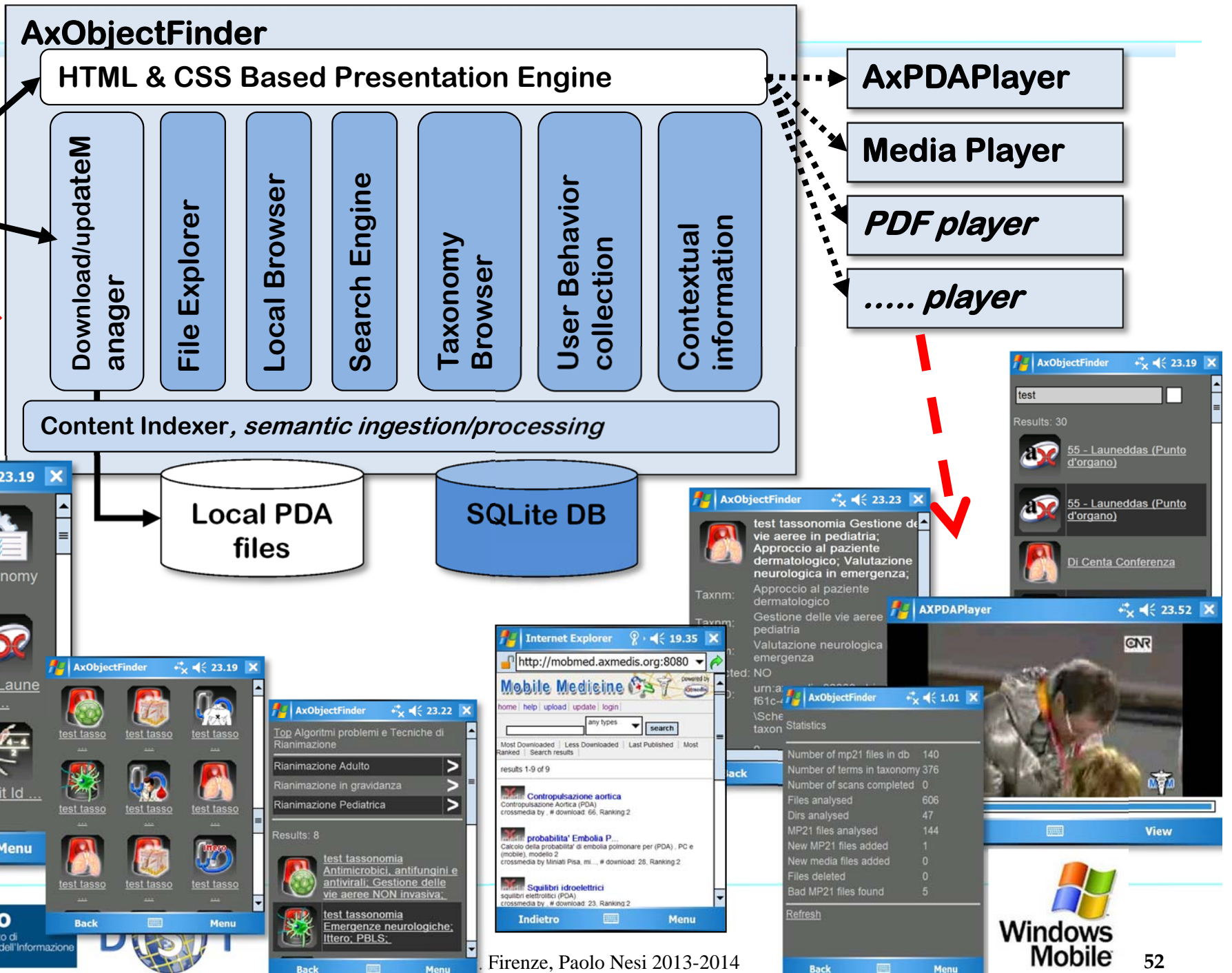

AxObjectFinder 23.19

Web Local Search Taxonomy

Open... 55 - Laune 55 - Laune

Algoritmo Calcolo BF Deficit Id ...

Back Menu

AxObjectFinder 23.19

test tasso test tasso test tasso

test tasso test tasso test tasso

test tasso test tasso test tasso

Back Menu

AxObjectFinder 23.22

Top Algoritmi problemi e Tecniche di Rianimazione

Rianimazione Adulto

Rianimazione in gravidanza

Rianimazione Pediatrica

Results: 8

test tassonomia Antimicrobici, antifungini e antivirali: Gestione delle vie aeree NON invasiva.

test tassonomia Emergenze neurologiche; Ilttero, P.B.L.S.

Back Menu

Internet Explorer 19.35

http://mobmed.axmedis.org:8080

Mobile Medicine

home help upload update login

any types search

Most Downloaded Less Downloaded Last Published Most Ranked Search results

results 1-9 of 9

Contropulsazione aortica (PDA)

crossmedia by: # download 66, Ranking 2

probabilita' Embolia P...

Calcolo della probabilita' di embolia polmonare per (PDA), PC e (mobile), modello 2

crossmedia by: # download 28, Ranking 2

Squilibri idroelettrici

squilibri idroelettrici (PDA)

crossmedia by: # download 23, Ranking 2

Indietro Menu

AxObjectFinder 23.23

test tassonomia Gestione de

vie aeree in pediatria; Approccio al paziente dermatologico; Valutazione neurologica in emergenza;

Taxnm: Approccio al paziente dermatologico

Taxnm: Gestione delle vie aeree pediatria

Valutazione neurologica emergenza

ted: NO

urn:a

f61c-

\Sche

taxon

Statistics

back

AXPDAPlayer 23.52

Number of mp21 files in db 140

Number of terms in taxonomy 376

Number of scans completed 0

Files analysed 606

Dirs analysed 47

MP21 files analysed 144

New MP21 files added 1

New media files added 0

Files deleted 0

Bad MP21 files found 5

Refresh

View

Windows Mobile

Semantic flows, MobMed



User Local Side

- User Profile
- User behavior
- Use data
- Content
 - DC+IDs
 - AXInfo: ver, prod., rights,...
 - Descriptors
 - Taxonomy
 - Groups

- Local User Profile
- Local User behavior
- Local Use data
- Content
 - DC+IDs
 - AXInfo: ver, prod, rights,
 - Descriptors
 - Taxonomy
 - Groups

• Recommendation
• Suggestions on the basis of user behavior

• Local Recommendation
• Local Suggestions on the basis of user behavior and local content



+ Content action data



Automazione della produzione

*Utente:
carica/propone
direttamente
contenuti
monofile*

*Utente: studia e
progetta mini
applicazioni
che poi possono
essere caricate*

*Produce in
modo assistito
procedure e
mini applicazioni*

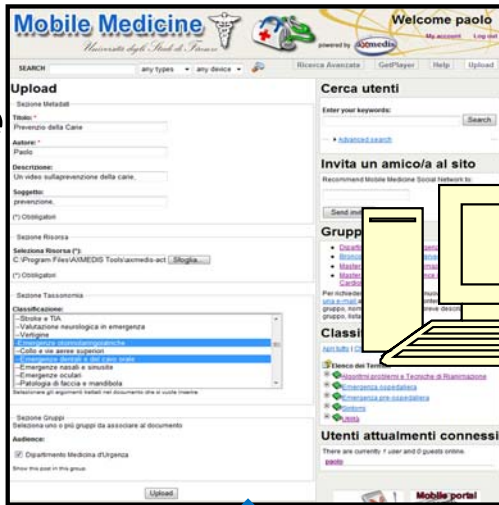

*ADMIN, valida,
manda in
pubblicazione*

*Back office
automatico
Adatta in modo
automatico*

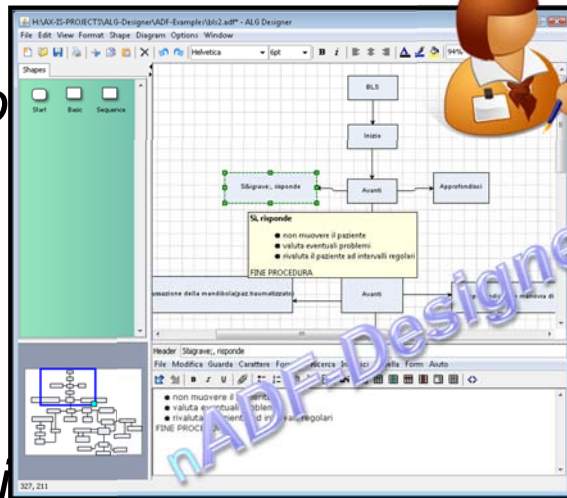

RADF-Designer





ADF Designer MobMed

H:\AX-IS-PROJECTS\ALG-Designer\ADF-Examples\bls2.adf* - ALG Designer

File Edit View Format Shape Diagram Options Window

Helvetica 6pt B i 94%

Shapes: Start Basic Sequence

```

    graph TD
      BLS[BLS] --> Inizio[Inizio]
      Inizio --> Avanti1[Avanti]
      Avanti1 --> Sgrave[S&grave;, risponde]
      Sgrave --> Avanti1
      Avanti1 --> Approfondisci1[Approfondisci]
      Avanti1 --> Avanti2[Avanti]
      Avanti2 --> Approfondimento[Approfondimento manovra di]
      Avanti2 --> Mandibola[Assunzione della mandibola(paz.traumatizzato)]
  
```

Header S`, risponde

File Modifica Guarda Carattere Formato Ricerca Inserisci Tabella Form Aiuto

- non muovere il paziente
- valuta eventuali problemi
- rivaluta il paziente ad intervalli regolari

FINE PROCEDURA

AXPDAPlayer

(versione draft, non approvata/validata)
 DAI DEA e Medicina e
 Chirurgia Generale e di Urgenza
SOD Osservazione Breve Intensiva

Scegli un farmaco!

ADRENALINA

AXPDAPlayer

AMIODARONE
 DILTIAZEM (D)
 DOBUTAMINA (D)
 DOPAMINA (R)
 EPARIN
 ISOSORBIDE DI
 File

← →

Adrenalina: fiale 1mg/1ml

P. siringa
 Diluizione: 3 f + 47 ml di SF o G5
 (1ml=60mcg)
 Dosaggio iniziale: 1-2 mcg/min=1-2 ml/h

P. volumetrica
 Diluizione: 1f in 250 ml di SF o G5
 (1ml=4mcg)
 Dosaggio iniziale: 1-2 mcg/min=15/30 ml/h

File View

Sommario



- | Problematiche dei sistemi mobili
- | Confronti fra SO e modelli di sviluppo
- | Distribuzione di contenuti per sistemi mobili
- | Modello di Programmazione iPhone
 - ♣ Si veda slide separate Parte 7a
- | Modello di Programmazione Android
- | Mobile Medicine
 - ♣ Windows Mobile
 - ♣ iPhone/iPad
 - ♣ Android
- | Content Organizer
- | Mobile Emergency
- | Mobiles and Sensors





Requisiti: Mobile Medicine

- | Connessione con portale per download
- | Play risorse di vario tipo
- | Gestione multilingua dell'interfaccia utente
- | Aggiornamenti automatici dei contenuti
- | Organizzazione dei contenuti in locale
- | Ricerca dei contenuti full text in locale, fuzzy
- | Tracciamento del comportamento dell'utente
- |



Mobile Medicine on iPhone

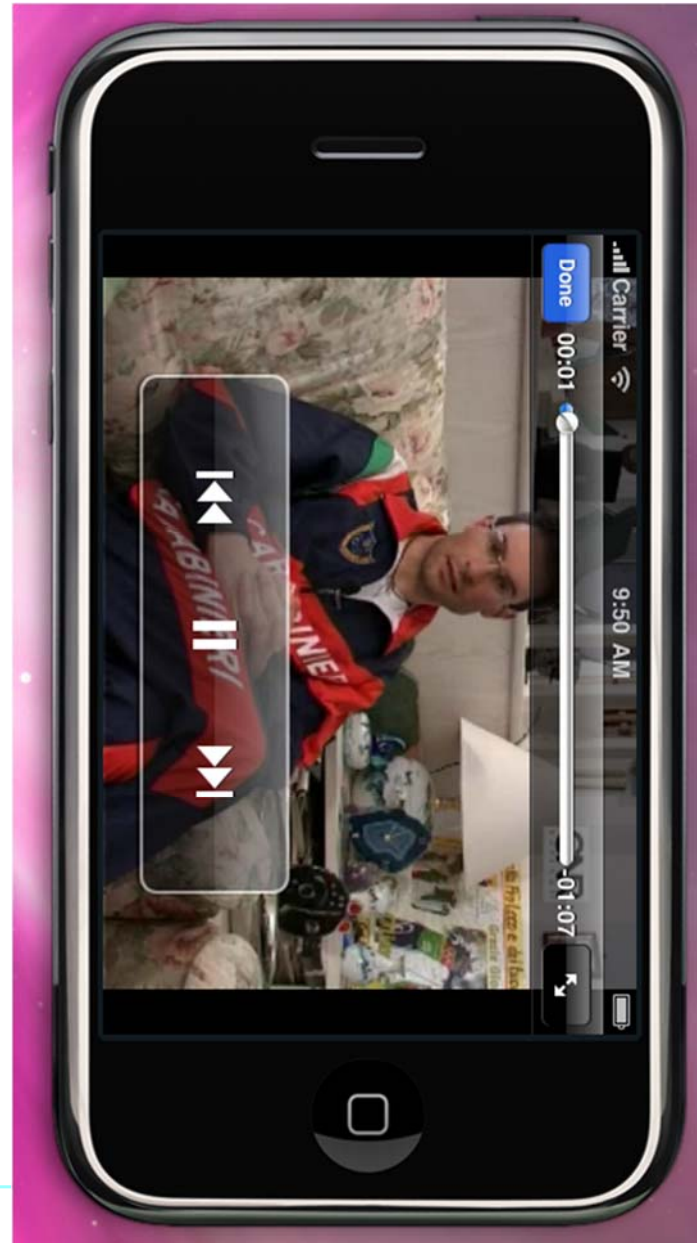



Mobile Medicine on iPhone





Architettura iPhone Application

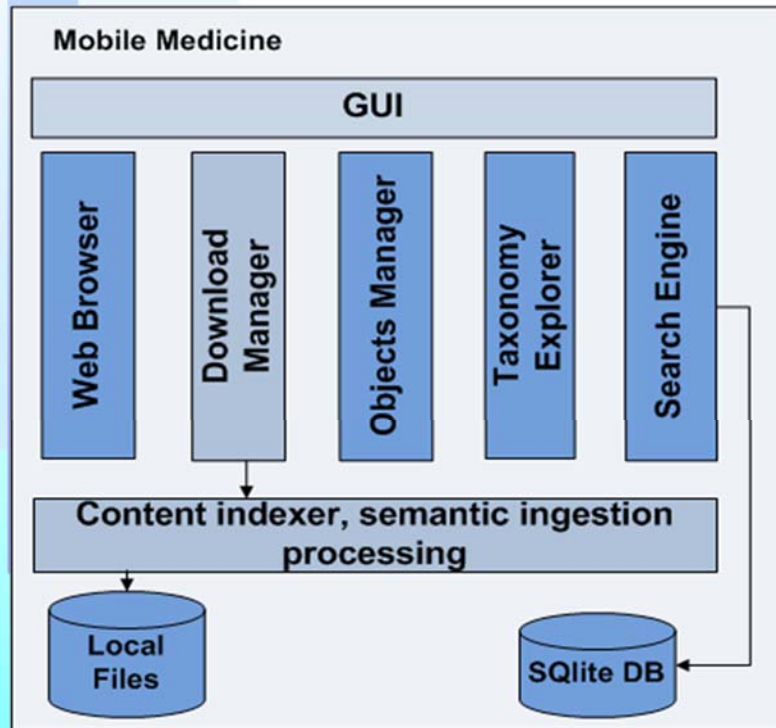

- ▶ Local Files
 - collezione locale
- ▶ SQLite DB
 - *informazioni semantiche* e statistiche di utilizzo

GUI

- interfaccia grafica per l'accesso ai servizi offerti dagli strati sottostanti

Web Browser

- navigazione tra i contenuti web e di Mobile Medicine

Download Manager

- trasferimento dei contenuti nel dispositivo locale

Objects Manager

- navigazione e gestione della collezione locale
- ordinamento della collezione
- visualizzazione dei contenuti

Taxonomy Explorer

- navigazione all'interno della collezione classificata sulla base di tassonomie mediche

Search Engine

- query sulla collezione locale sulla base di informazioni di carattere semantico

Content Indexer, semantic ingestion processing

- indicizzazione e classificazione semantica dei contenuti acquisiti



Gestore collezione locale

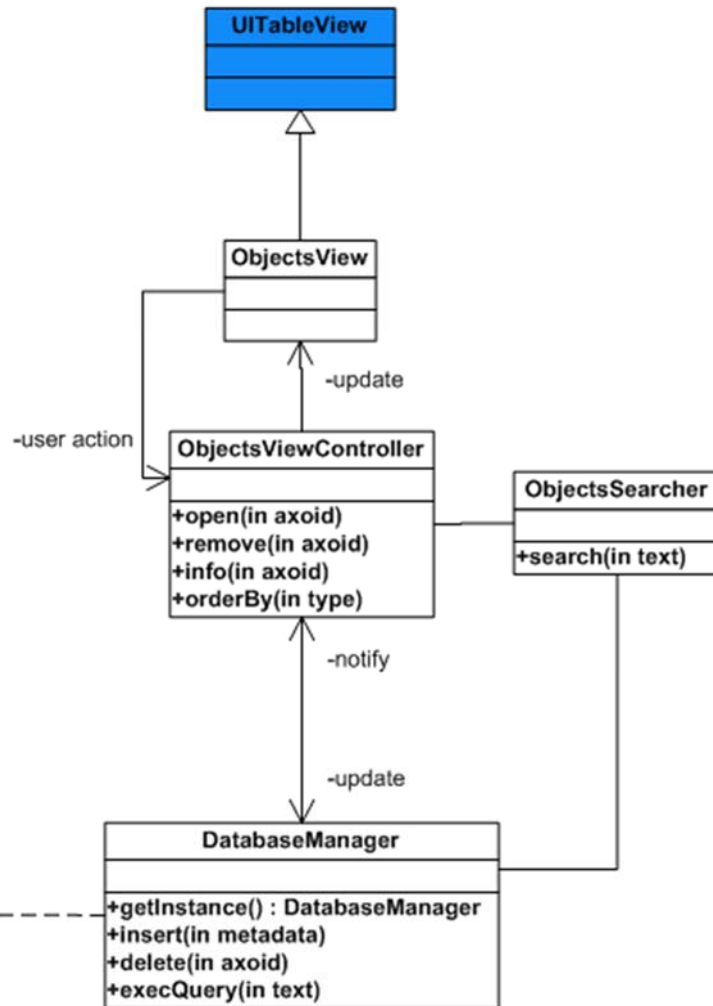

- | Visualizzazione di un contenuto della collezione
 - ♣ aggiornamento delle relative statistiche di utilizzo: numero di utilizzi e data dell'ultimo utilizzo
- | Visualizzazione delle informazioni semantiche associate
- | Ordinamento della collezione
 - ♣ per titolo
 - ♣ per dimensione
 - ♣ per tipo/formato
 - ♣ in base ai contenuti più/meno utilizzati
 - ♣ in base ai contenuti più/meno recentemente utilizzati
- | Eliminazione di un contenuto
 - ♣ eliminazione delle risorse fisiche
 - ♣ eliminazione dei metadati
- | Ricerca nella collezione locale sulla base di informazioni semantiche
 - ♣ query sulla base di dati SQLite e visualizzazione del risultato all'utente



Gestore tassonomie

- ▮ Navigazione della sotto-collezione classificata sulla base di tassonomie mediche

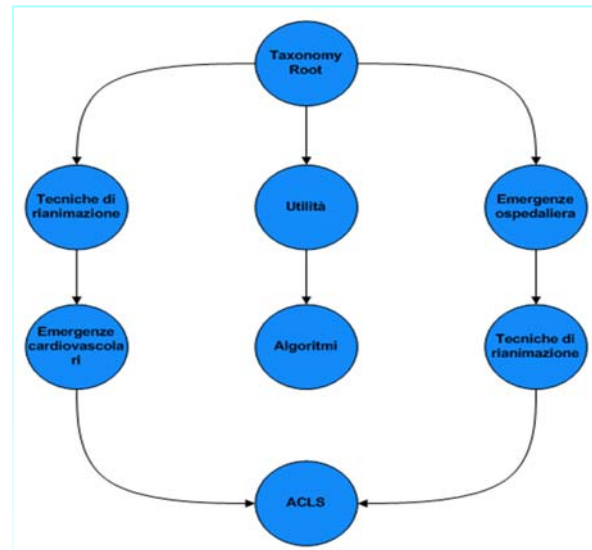
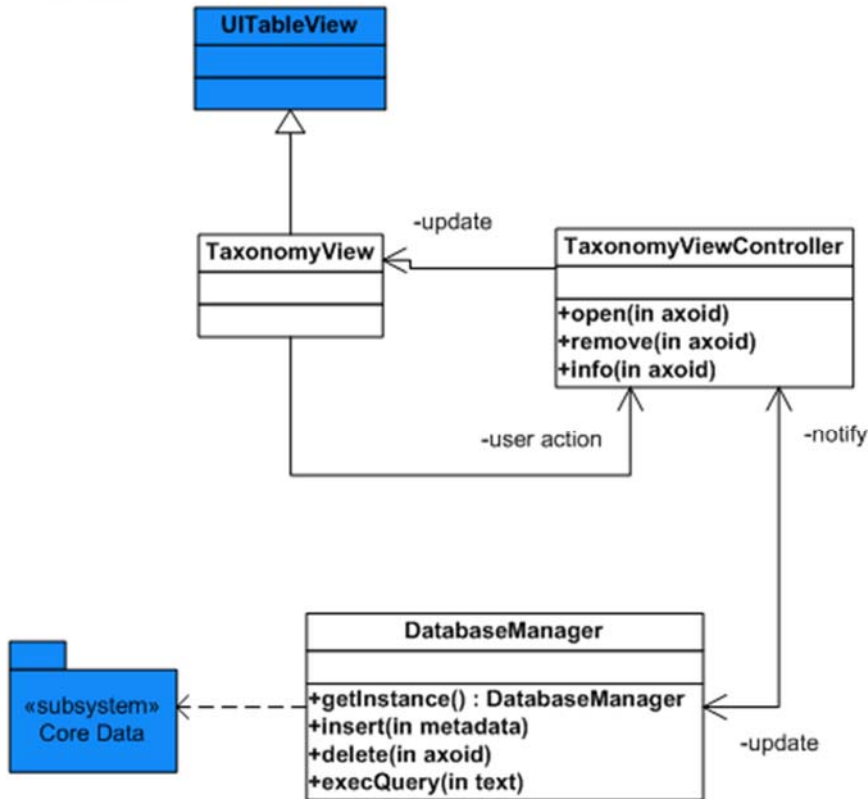

Struttura a dendrogramma dove ogni nodo classifica un insieme della collezione

- Visualizzazione del contenuto degli oggetti classificati
- Rimozione delle risorse



Web Browser

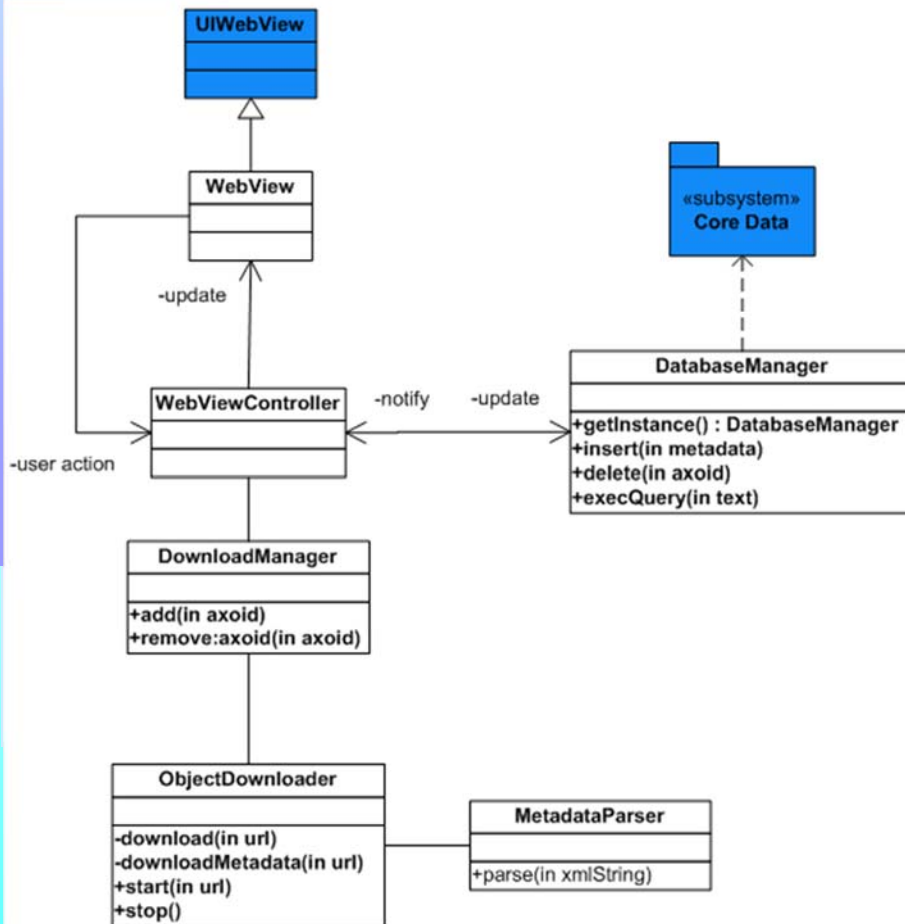

Browser web per l'accesso ai servizi offerti da Mobile Medicine
Trasferimento ed indicizzazione dei contenuti sul dispositivo locale

- Trasferimento e parsing di un descrittore in formato XML delle informazioni semantiche associate
 - metadati Dublin Core
 - informazioni di identificazione
 - informazioni tassonomiche
 - struttura fisica del contenuto
- Trasferimento ed indicizzazione delle risorse fisiche
 - memorizzazione delle risorse nel file system locale del dispositivo
 - inizializzazione delle statistiche di utilizzo



Base di dati locale

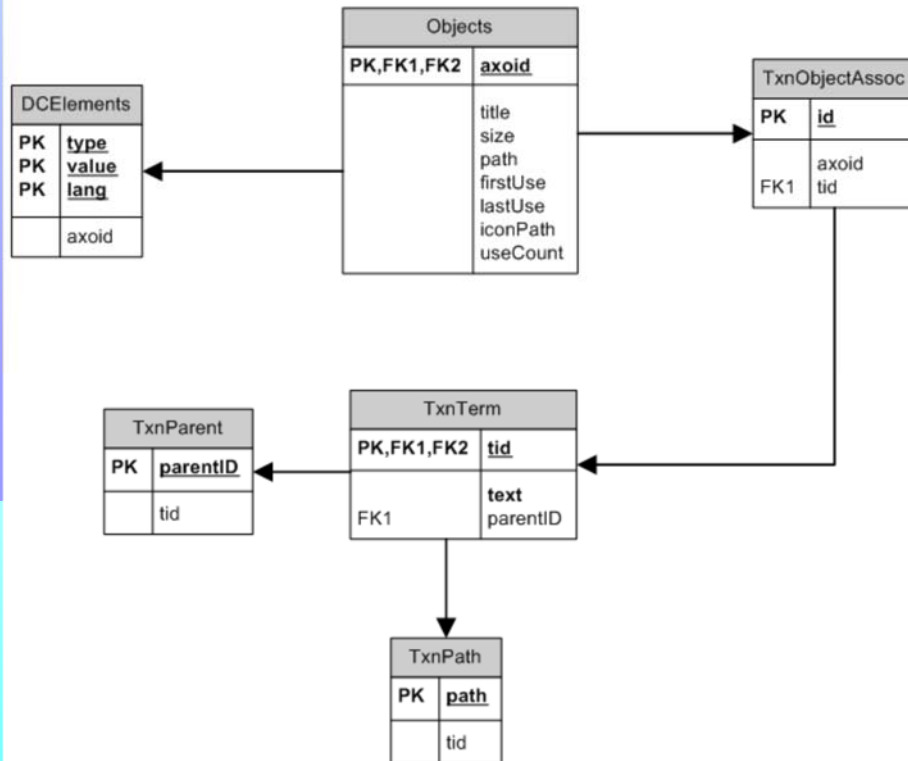

Informazioni fisiche e di identificazione del contenuto

- ♣ identificativo
- ♣ percorso fisico
- ♣ titolo
- ♣ dimensione

Informazioni di utilizzo del contenuto

- ♣ Data del primo utilizzo
- ♣ Data dell'ultimo utilizzo
- ♣ Numero di utilizzi

Metadati Dublin Core associati al contenuto

- ♣ autore, data di creazione, formato, descrizione testuale, etc...

Informazioni di classificazione tassonomica

- ♣ grafo delle tassonomie
- ♣ percorsi del grafo
- ♣ associazioni tra i nodi del grafo e i contenuti multimediali



Risultati – Acquisizione contenuto



The screenshots show the 'Mobile Medicine Social' app interface. The top bar includes 'Gestore', signal strength, Wi-Fi, and time (12:52 PM, 11:57 AM, 12:06 PM). The main content area displays a list of items with their names and sizes. The following table summarizes the items shown in the screenshots:

Item Name	Size
Classificazione Neurologi...	252.28 KB
EGA - EMOGASANALISI...	22.44 KB
Il fegato	17.46 KB
Mobile Medicine short pr...	3.23 MB
Procedura Prevenzione e...	62.47 KB
Protocols Farmaci Dip... (circled)	140.66 KB
Tachicardia con polso	29.95 KB
Valutazione Stato di Cosc...	25.05 KB

The bottom navigation bar contains icons for 'Oggetti', 'Browser', and 'Tassonomie'.



Risultati, iPhone MobMed



ndownload



ncontenuto



ncontenuto

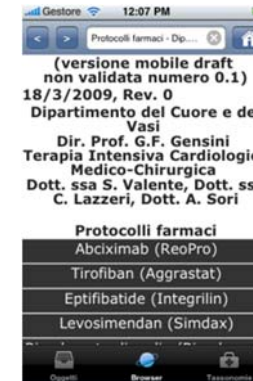

nstruttura
ncontenuto





Fruizione contenuti: metadati, iPhone MobMed

Informazioni di classificazione

Metadati Dublin Core

- Titolo, creatore, descrizione, data di creazione, etc...

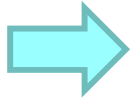

```
<AxmedisObject axoid="28dd8e1695ed4676b967eb0e28cc8a63">
<DublinCore>
<title>Protocolli Farmaci Dip. Cuore e Vasi</title>
<creator>Dott. ssa S. Valente</creator>
<format>crossmedia</format>
<subject>Protocolli Farmaci Dip. Cuore e Vasi,</subject>
<description>Calcolatori per calcolo dosi.</description>
</DublinCore>
</AxmedisObject>
```

Struttura fisica del contenuto

- HTML, pdf, immagini, audio, video, etc...

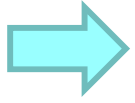

```
<Resource path="index.html"/>
<Resource path="stile.css"/>
<Resource path="axicon.png"/>
<Resource path="integrilin.html"/>
<Resource path="simdax.html"/>
<Resource path="reopro.html"/>
<Resource path="aggrastat.html"/>
<Resource path="bicarbonato.html"/>
```

```
<category vocabulary="Classificazione">Emergenza ospedaliera</category>
<category vocabulary="Classificazione">Emergenze cardiovascolari</category>
<category vocabulary="Classificazione">Formule utili</category>
```

Classificazione tassonomica

- Struttura a dendogramma
- ogni nodo raggruppa una sotto-collezione di oggetti

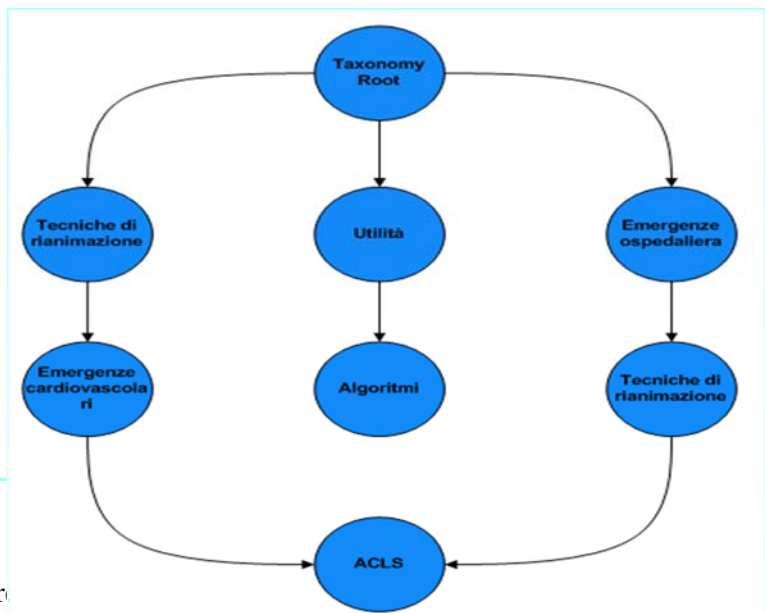
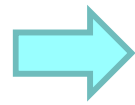

Sommario



- | Problematiche dei sistemi mobili
- | Confronti fra SO e modelli di sviluppo
- | Distribuzione di contenuti per sistemi mobili
- | Modello di Programmazione iPhone
 - ♣ Si veda slide separate Parte 7a
- | Modello di Programmazione Android
- | Mobile Medicine
 - ♣ Windows Mobile
 - ♣ iPhone/iPad
 - ♣ Android
- | Content Organizer
- | Mobile Emergency
- | Mobiles and Sensors



ITALIA DEGLI INNOVATORI
Agenzia per la Diffusione delle Tecnologie per l'Innovazione
Presidenza del Consiglio dei Ministri



ITALIA DEGLI INNOVATORI
Agenzia per la Diffusione delle Tecnologie per l'Innovazione
Presidenza del Consiglio dei Ministri

Con. Org su Android

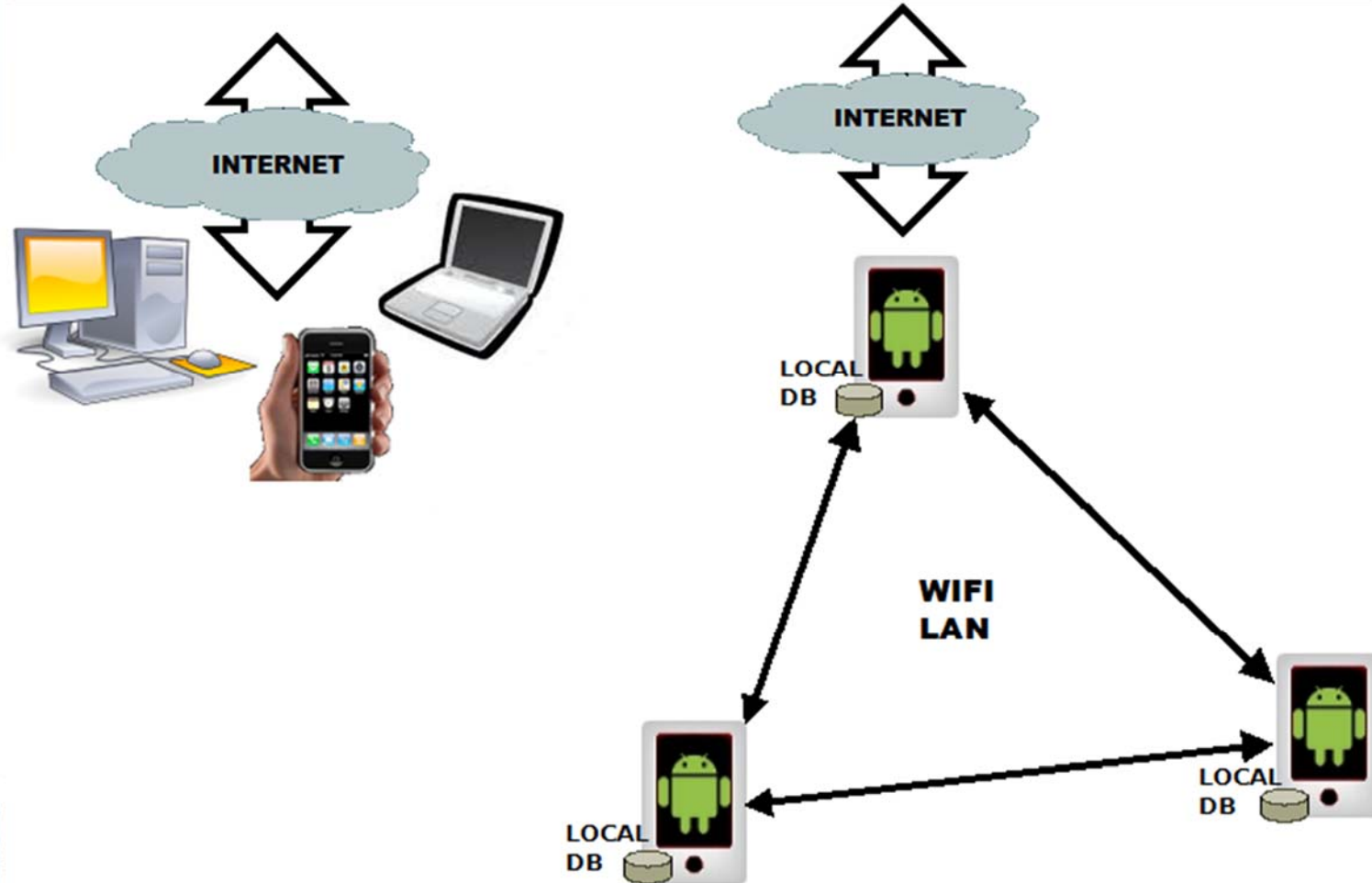
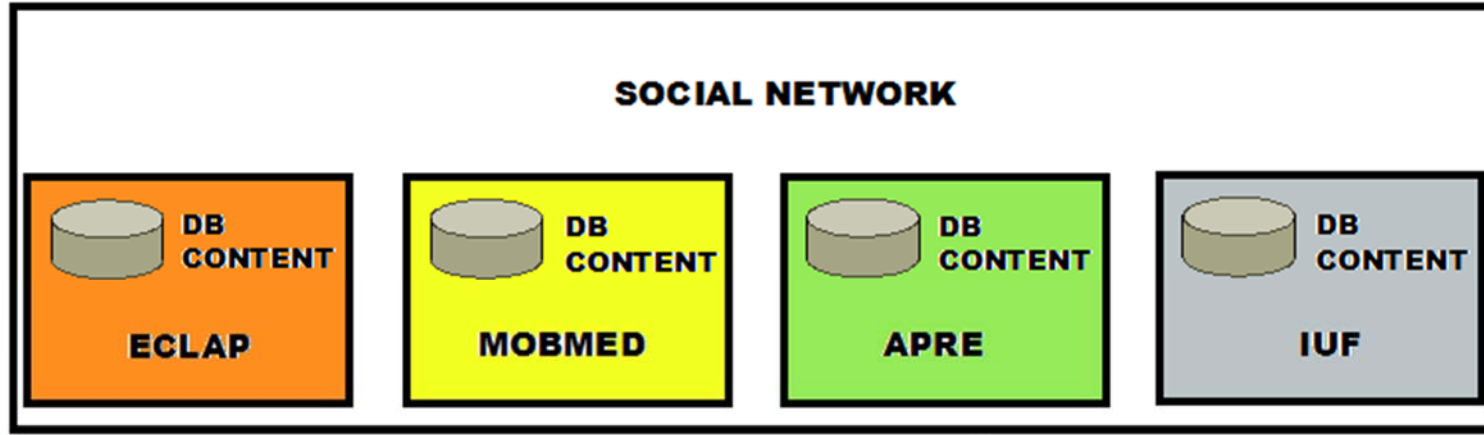

Casi d'uso

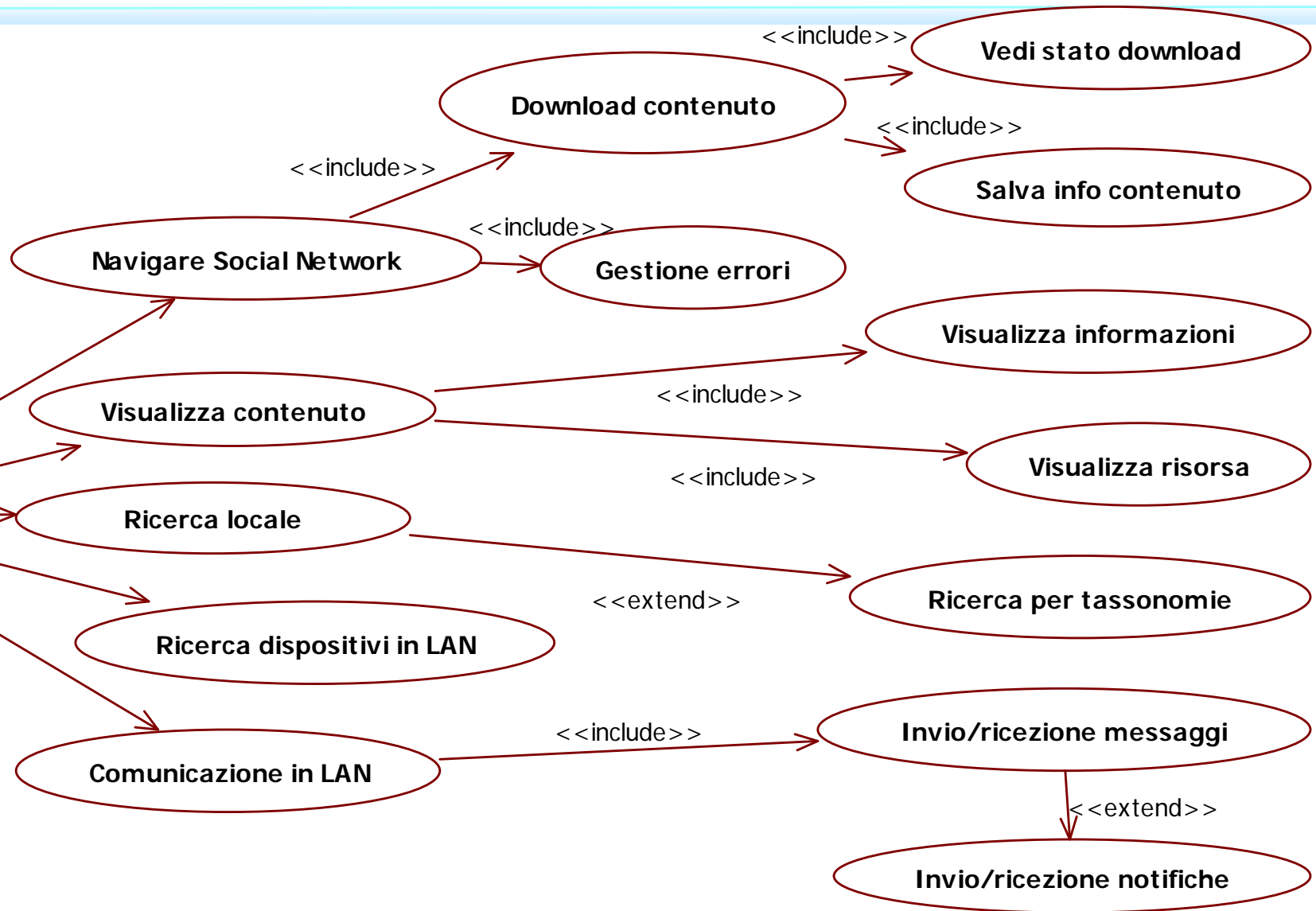



Modello dei dati



Modello dei dati per la gestione dei contenuti

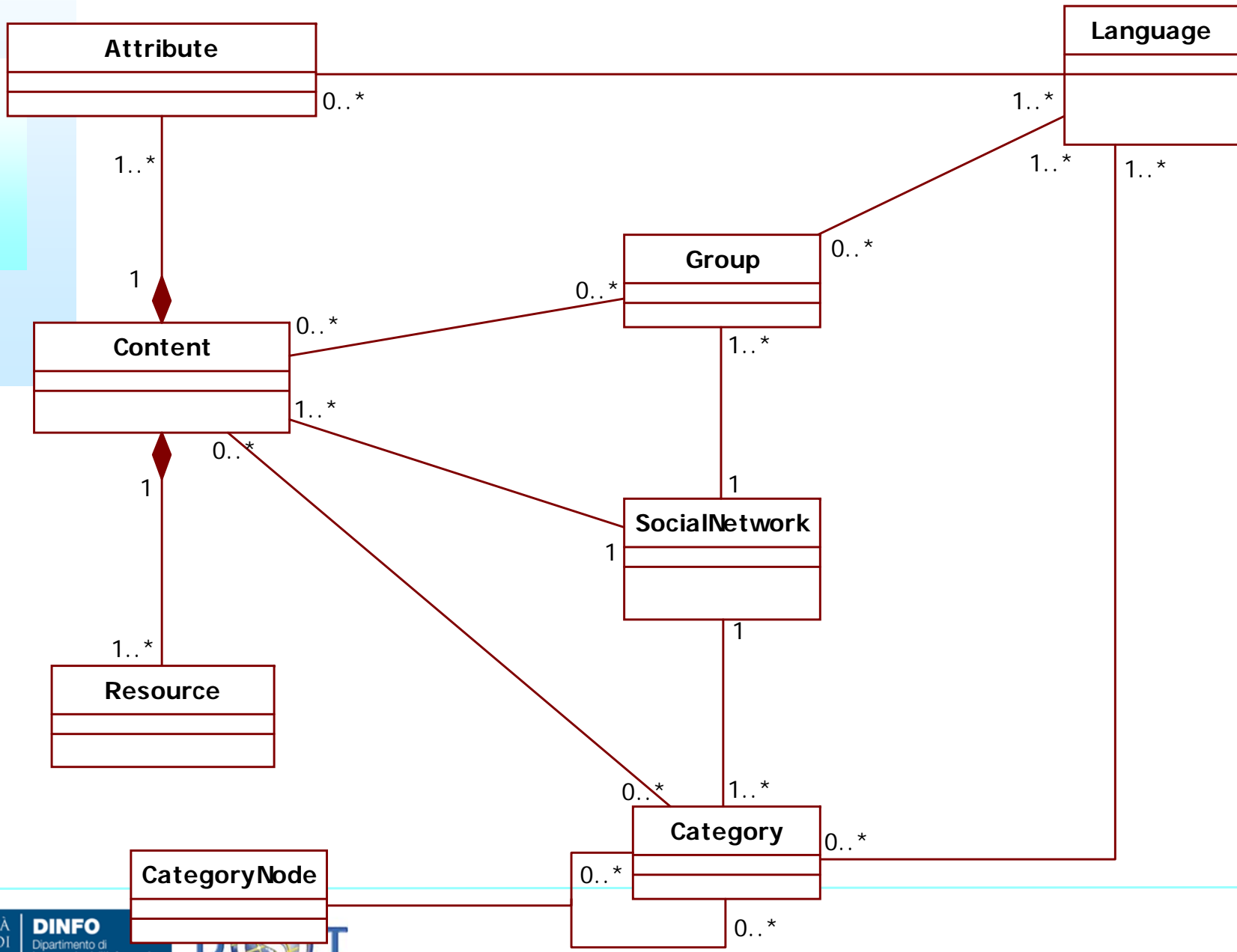



Architettura dell' *Applicazione*



Architettura dell'applicazione per Android 2.3 Gingerbread

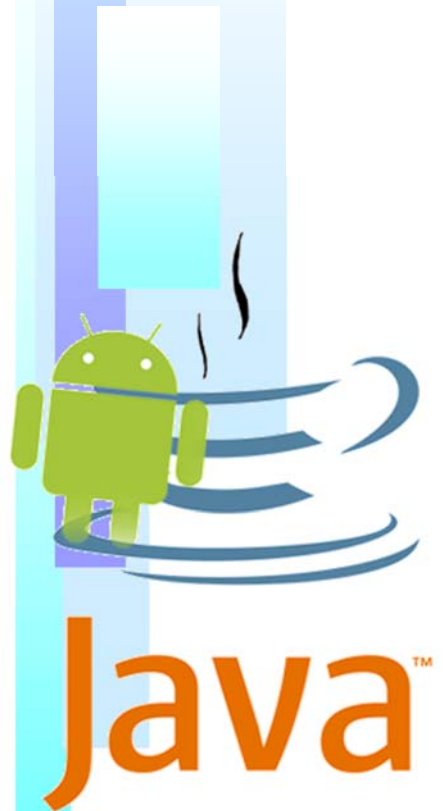
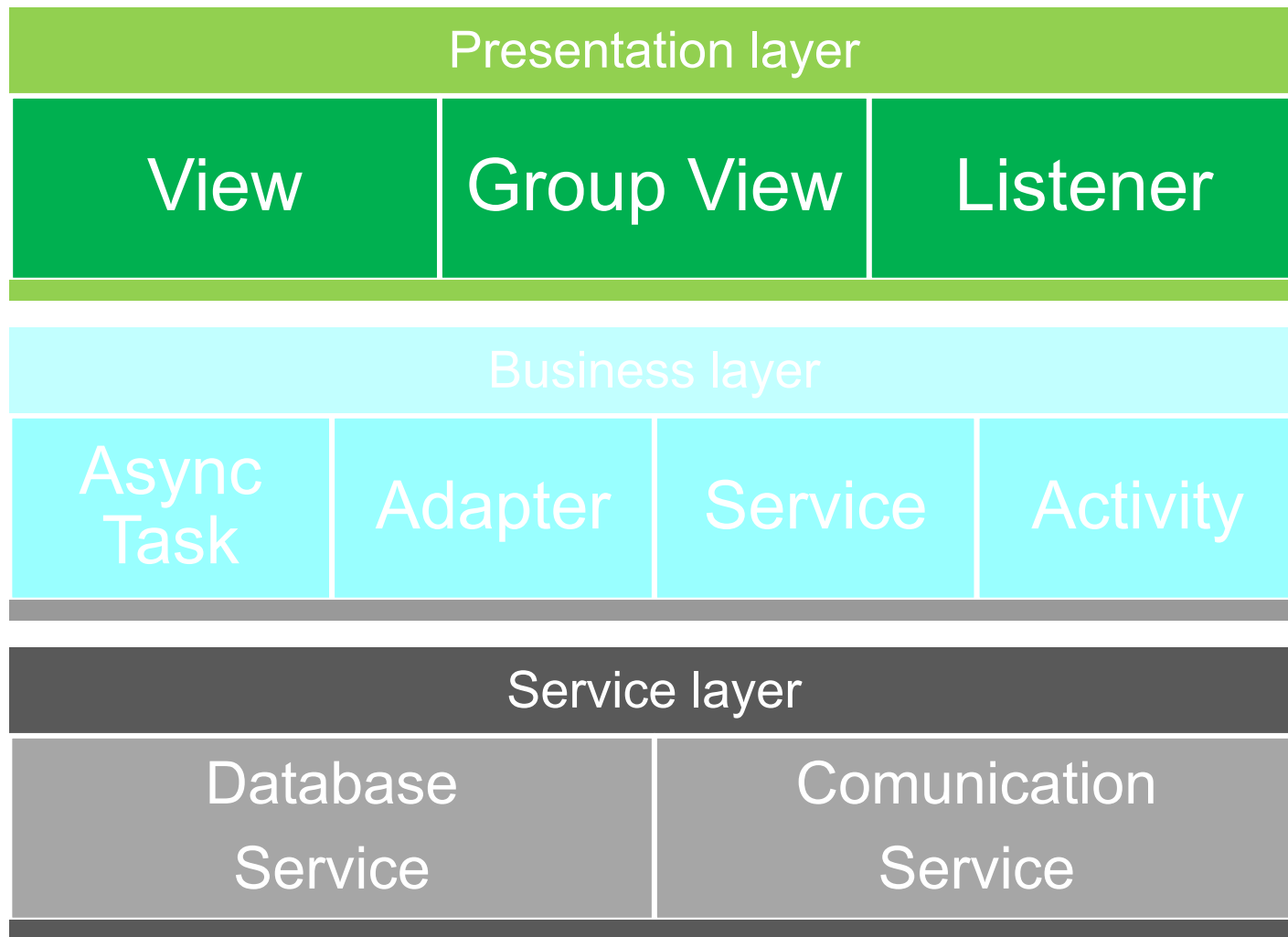

- *Discovery*
- *Descrizione*
- *Controllo*



nAnalizziamo una parte dell'applicazione:

▶ **Content Manager**

nFunzionalità implementate:

- ▶ *Navigazione dei portali(IUF,ECLAP,...)*
- ▶ *Download dei contenuti multimediali*
- ▶ *Ricerca dei contenuti locali*
- ▶ *Ordinamento dei contenuti locali*
- ▶ *Visualizzazione delle categorie dei contenuti*

Content Manager 2/2

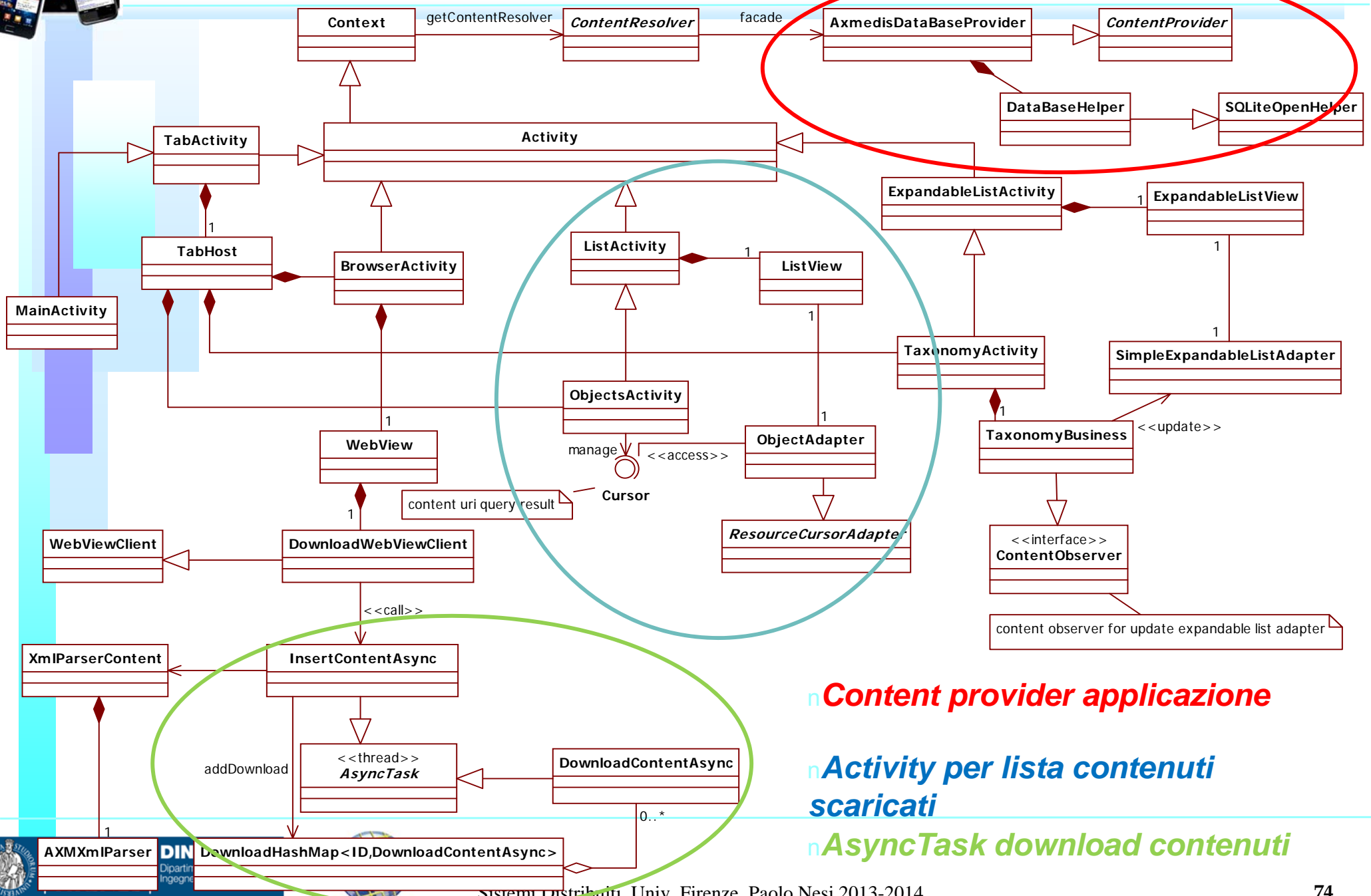

n Content provider applicazione

n Activity per lista contenuti scaricati

n AsyncTask download contenuti



Sequenza per il download

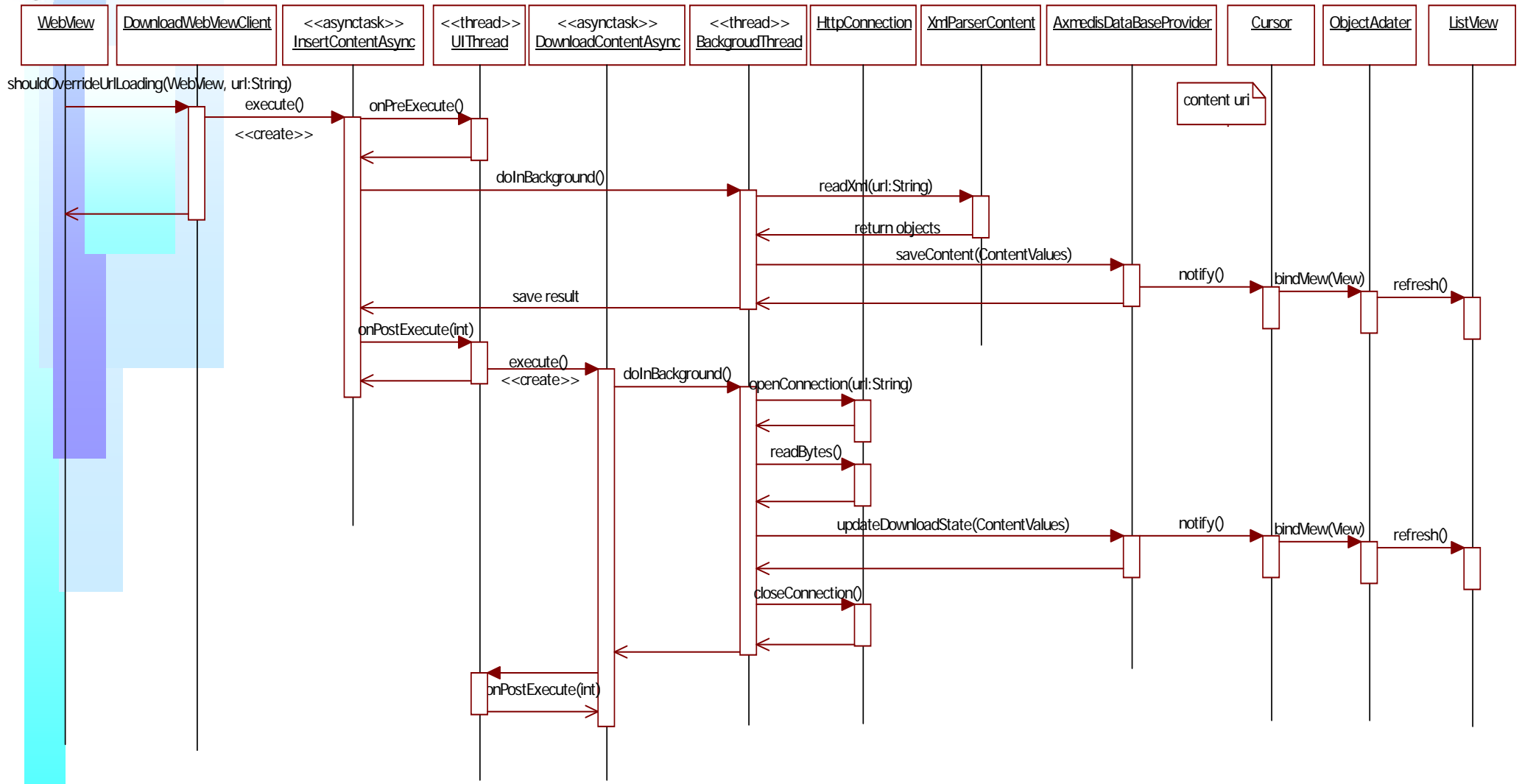

Istantanee dall'applicazione

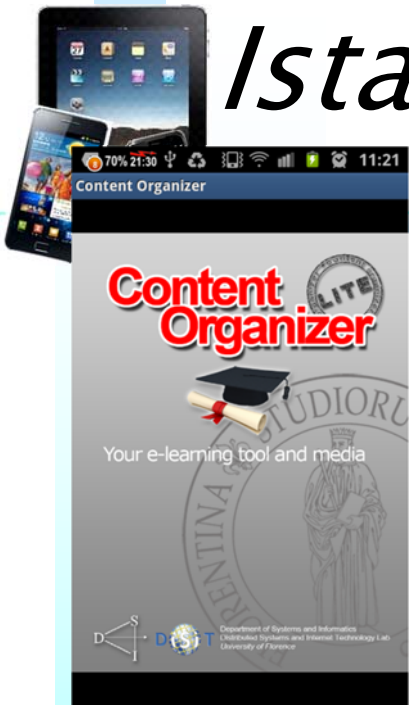

Splash screen



Click download

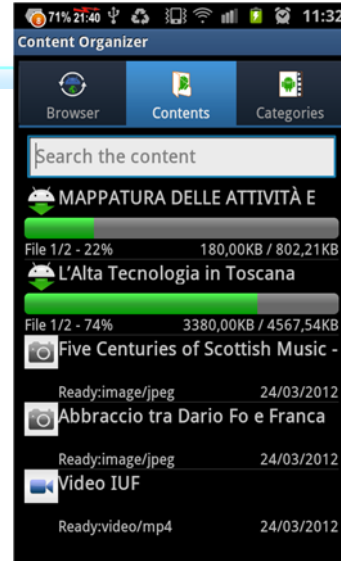

Doppio download

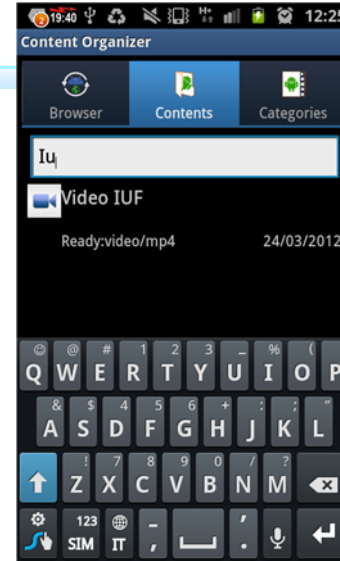

Ricerca

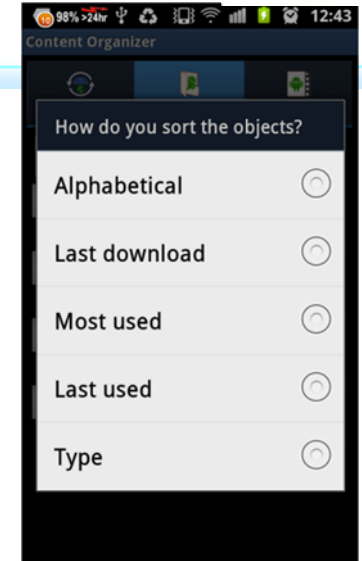

Ordinamento

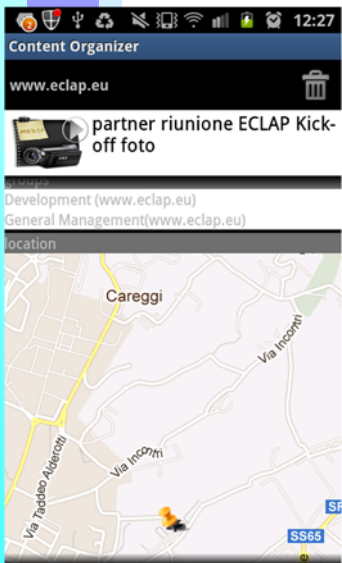

Info + Google Maps

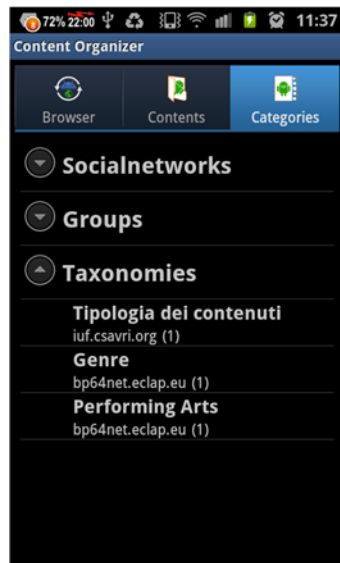

Tassonomie

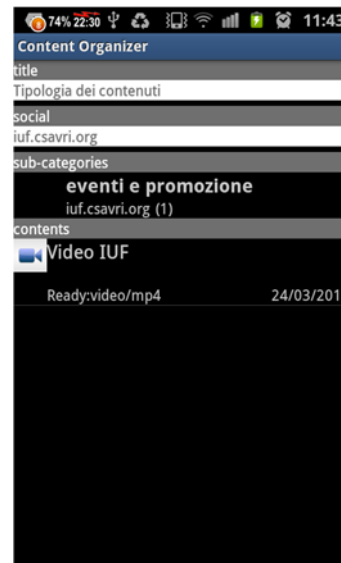

Naviga tassonomie

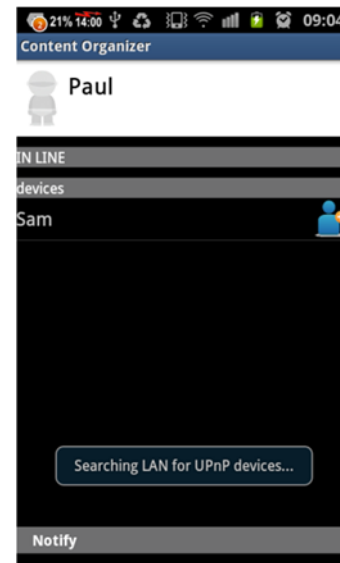

Discovery

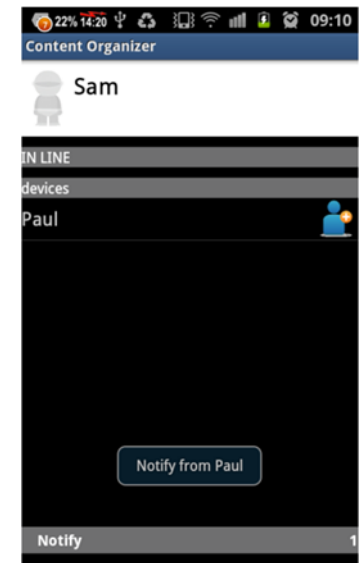

Ricevere notifiche



Sommario



- | Problematiche dei sistemi mobili
- | Confronti fra SO e modelli di sviluppo
- | Distribuzione di contenuti per sistemi mobili
- | Modello di Programmazione iPhone
 - ♣ Si veda slide separate Parte 7a
- | Modello di Programmazione Android
- | Mobile Medicine
 - ♣ Windows Mobile
 - ♣ iPhone/iPad
 - ♣ Android
- |  Content Organizer
- | Mobile Emergency
- | Mobiles and Sensors



ITALIA DEGLI INNOVATORI
Agenzia per la Diffusione delle Tecnologie per l'Innovazione
Presidenza del Consiglio dei Ministri



ITALIA DEGLI INNOVATORI
Agenzia per la Diffusione delle Tecnologie per l'Innovazione
Presidenza del Consiglio dei Ministri

Content Organizer on mobiles



- | Content collection
- | Search/query
- | Navigations.. taxonomy
- | Suggestions
- | ...

Video of the Content Organizer:

<http://bpnet.eclap.eu/drupal/?q=en-US/home&axoid=urn:axmedis:00000:obj:ea5eb861-18b6-4262-8d4b-77b3d3c084f0>

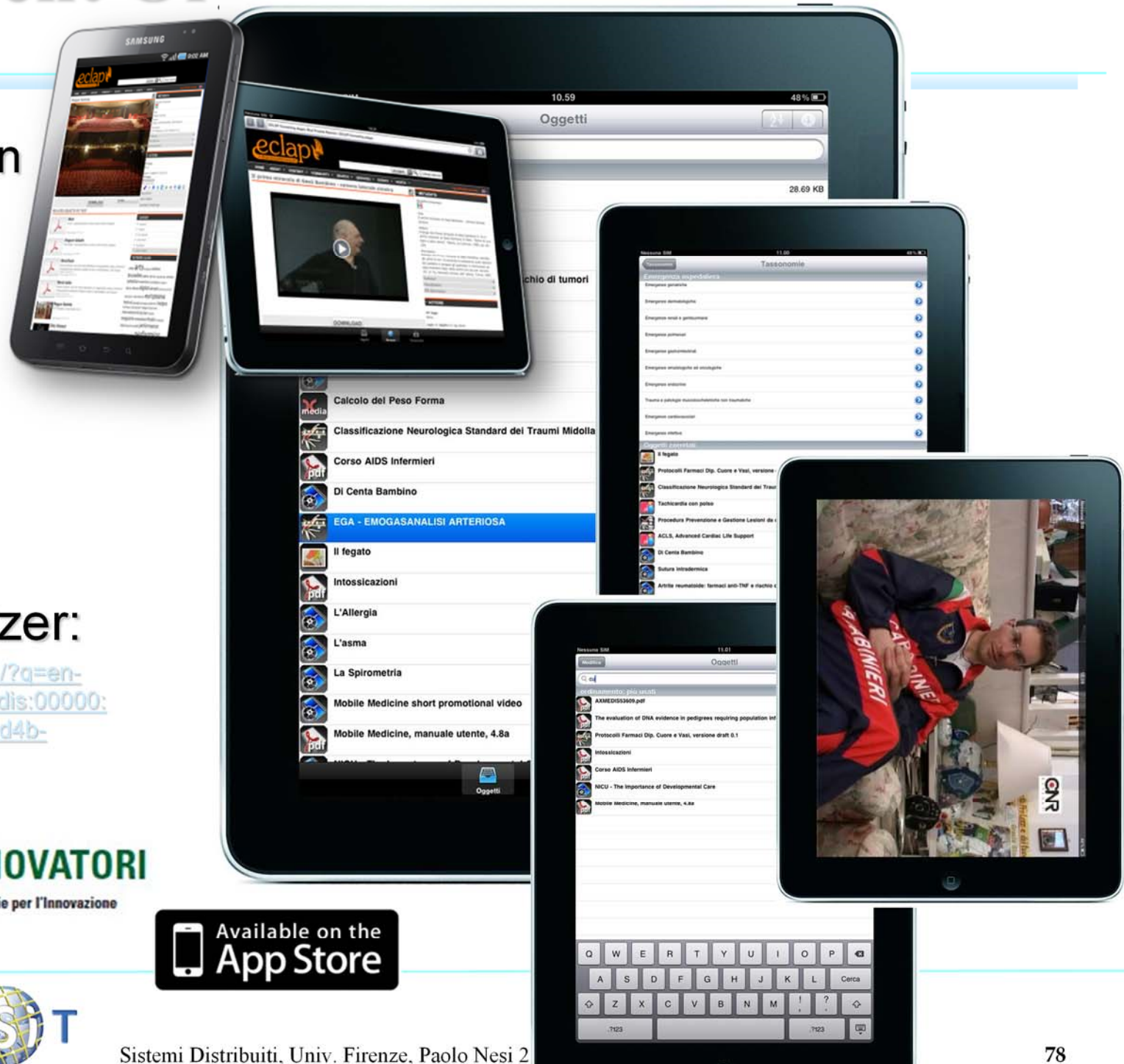

ITALIA DEGLI INNOVATORI

Agenzia per la Diffusione delle Tecnologie per l'Innovazione
Presidenza del Consiglio dei Ministri



Content Organizer on mobiles



- | Content collection
- | Search/query
- | Navigations.. taxonomy
- | Suggestions

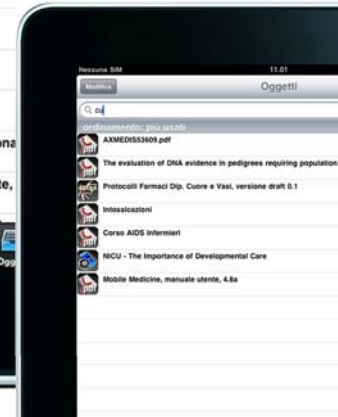
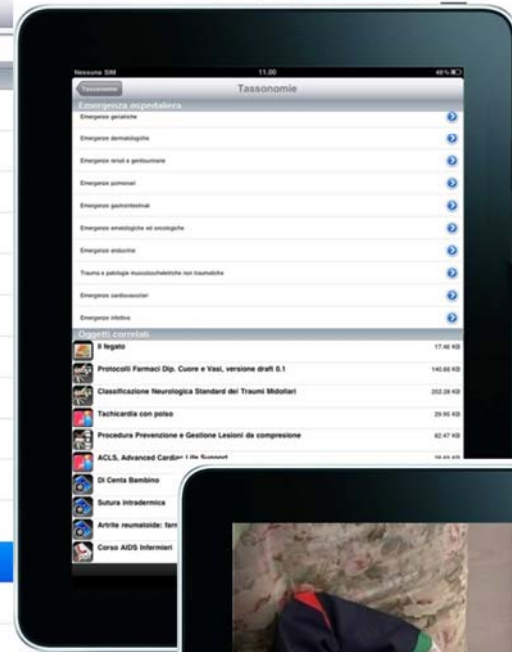
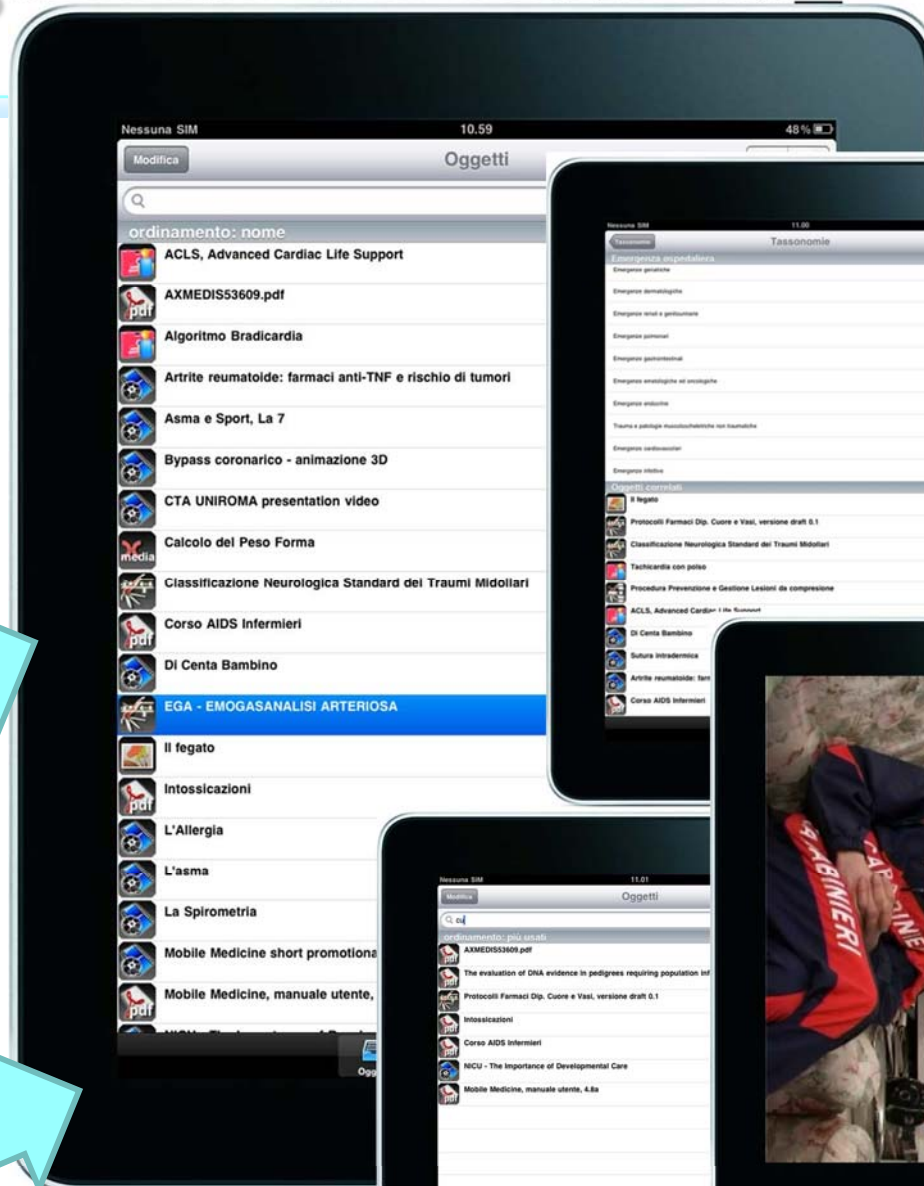

Available on the
App Store



ITALIA DEGLI INNOVATORI

Agenzia per la Diffusione delle Tecnologie per l'Innovazione
Presidenza del Consiglio dei Ministri

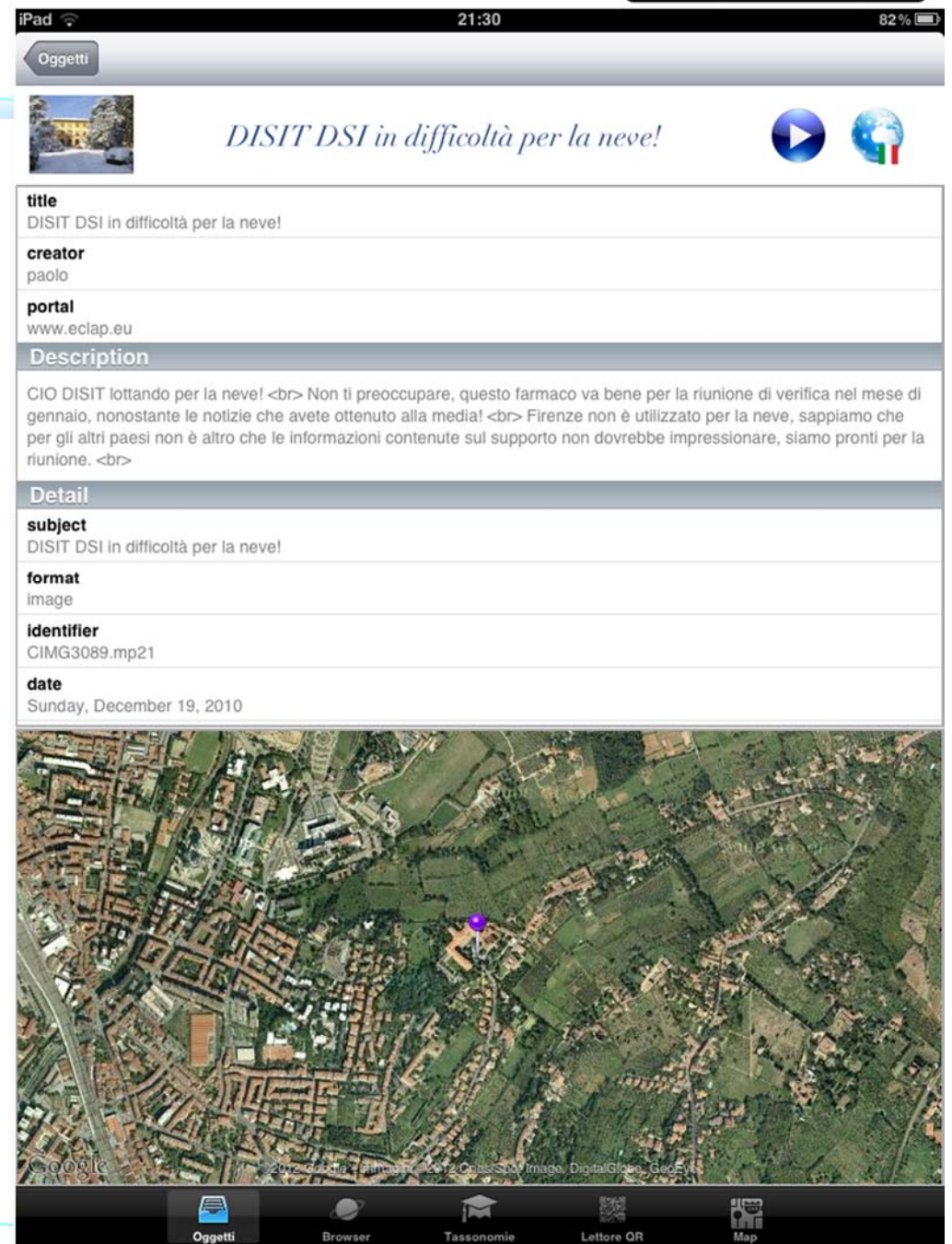

Semantic Flows



- AXCP backoffice**
- Grid Scheduler
 - Grid Node
 - Grid Node
 - Grid Node

Rule based system
 Automated formatting
 Inferential engine processing
 Adaptation enrichment
 Multilingual index and search
 Text Analysers
 Indexer
 Fuzzy search

- Suggestions
- Similarity distances
 - Clustering

AXCP BackOffice

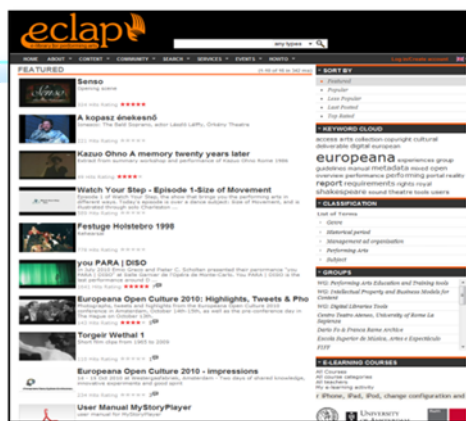

User Profile
 Dynamic User Profile
 User behavior
 Use data
 Content
 DC+IDs
 AXInfo: ver, prod., rights,..
 Descriptors
 Groups: users, content..
 Ontology/Taxonomy Domain

Suggestions on the basis of:
 Static and dynamic user profile,
 descriptors, domain

Front End Portal



Local User Profile
 Local Dynamic User Profile
 Local User behavior
 Local Use data
 Content
 DC+IDs
 AXInfo: ver, prod, rights,
 Descriptors
 Groups
 Taxonomy classification

Content Organiser

Local Suggestions on the basis of
 user profiles, local content, local
 collected data



contributions,
 actions on
 content,
 social actions,
 preferences,
 queries,
 use data,..



Content Organizer and Players Users



Altre Feature

- | Gestione di echo su schermo esterno via cable
- | Inserimento della gestione di contenuti in formato ePUB
- | Acquisizione di contenuti da piu' social network
- | Gestione dinamica di Tassonomie
- | Chat diretta fra piu' utenti
- | Acquisizione di contenuti Cross Media: corsi e collezioni
- | iPhone:
 - ♣ acquisizione di immagini e video per upload automatico su social network,
 - ♣ Location GPS integrata, WiFi



Feature

- | Inserimento di meccanismi di DRM
 - ♣ Autenticazione, certificati
 - ♣ Protezione dei contenuti tramite encryption
 - ♣ Decryption on fly
- | Acquisizione in automatico degli aggiornamenti
- | Collezionamento di maggiori dati di uso ed invio di questi dati di uso verso il server
- | Scambio di contenuti in modo diretto tramite wifi, etc...
- | iPhone:
 - ♣ acquisizione di immagini e video per upload automatico su social network,
 - ♣ Location GPS integrata, WiFi



Sviluppi

- ▶ *Upnp e DLNA (The Digital Living Network Alliance)*
- ▶ *Molti dispositivi elettronici utilizzano questa tecnologia (Smart TV, PS3,...)*
- ▶ *Possibilità di integrare la comunicazione della nostra applicazione con questi dispositivi*

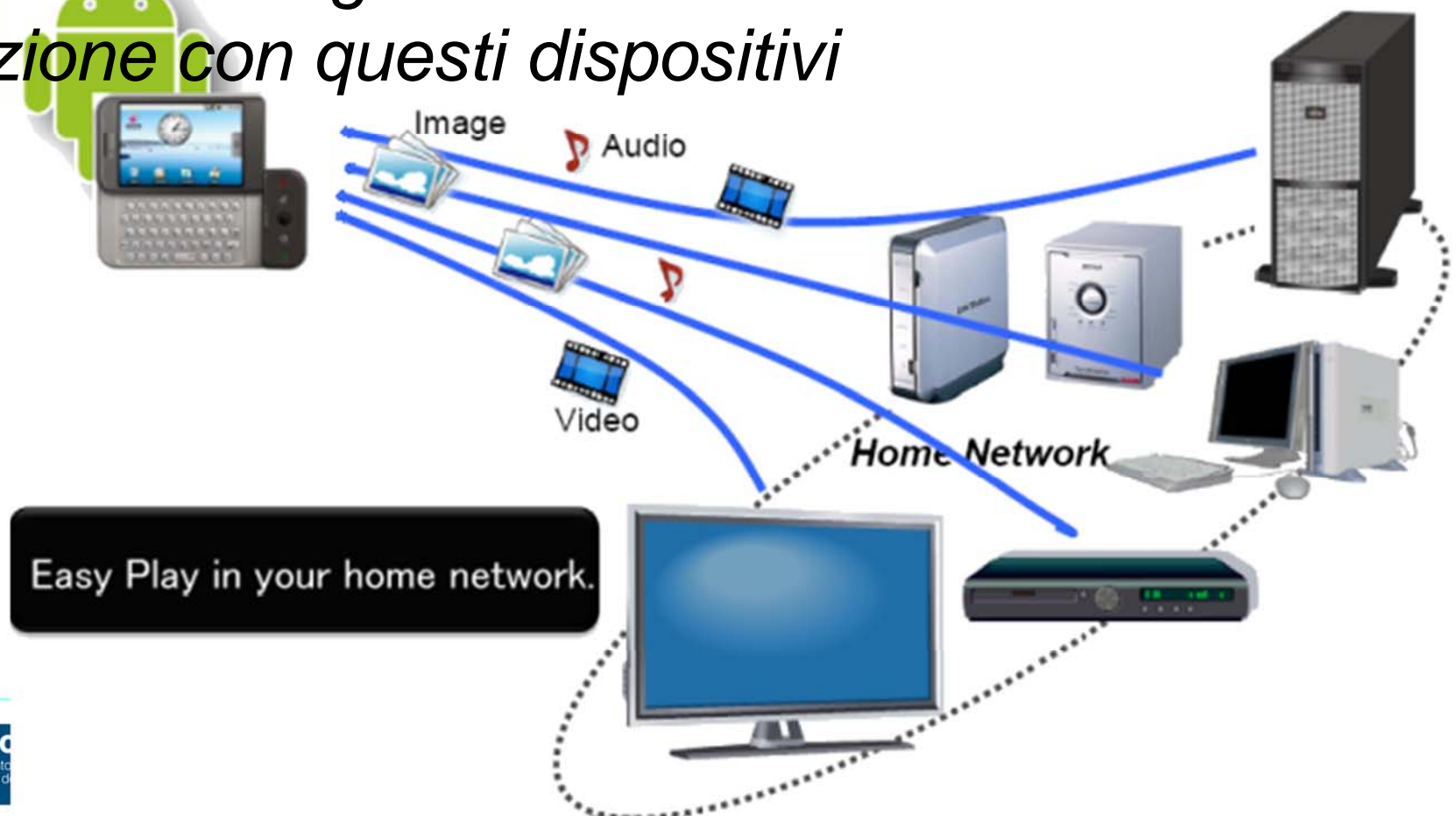



Content Sharing 1 / 2



nAnalizziamo una parte dell'applicazione:

▶ **Content Sharing**

nFunzionalità implementate:

- ▶ *Salvataggio delle informazioni dell'utente che sta utilizzando il dispositivo mobile (nome, status)*
- ▶ *Ricerca dei dispositivi che implementano la tecnologia UPnP presenti in rete locale*
- ▶ *Richiesta di connessione ai dispositivi presenti in rete locale*
- ▶ *Invio/ricezione dei messaggi ad altri dispositivi connessi in rete locale*

Content Sharing 2/2

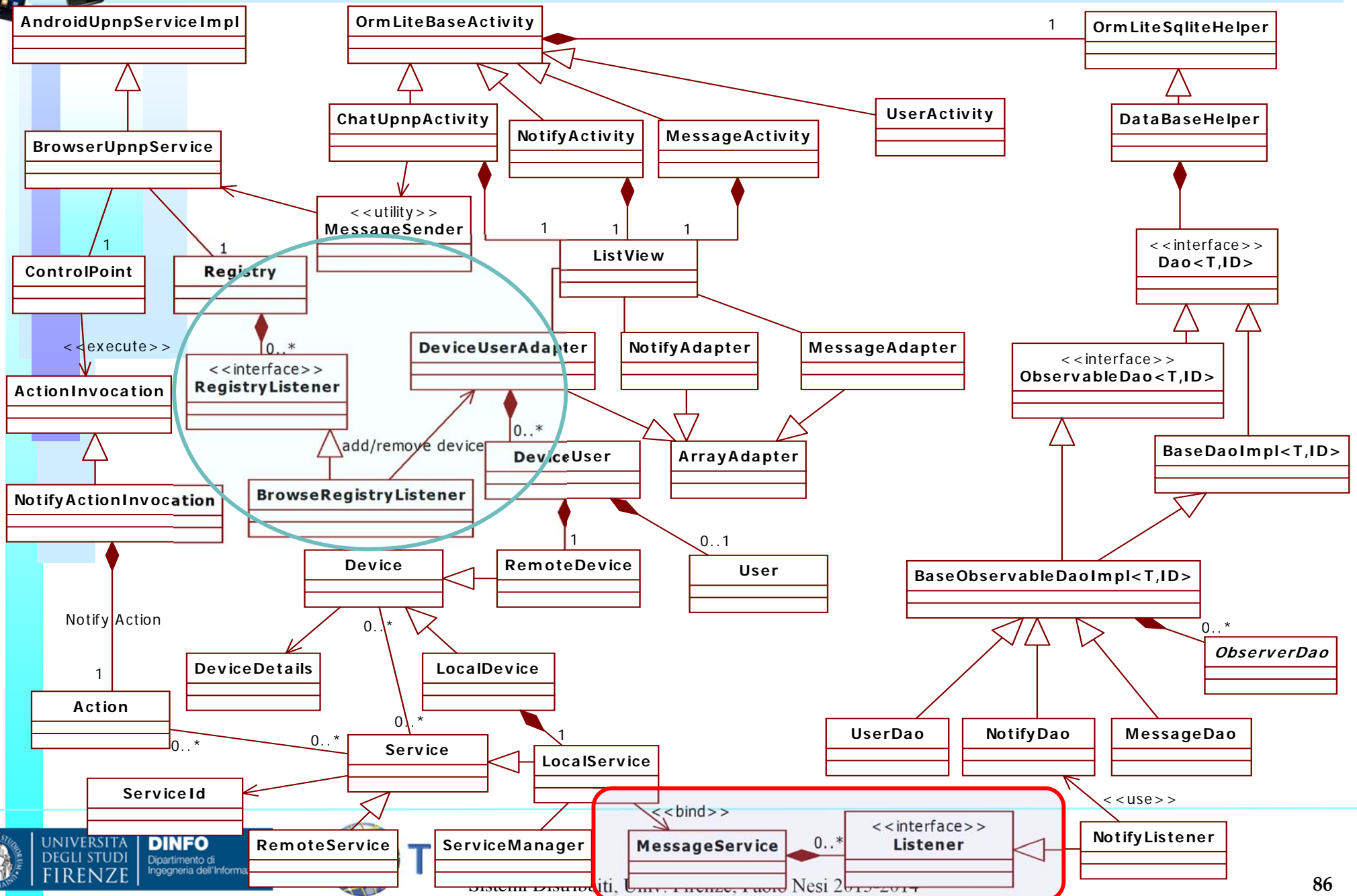

Inviare / ricevere notifiche



Diagramma di sequenza per l'invio/ricezione delle notifiche di richiesta di collegamento

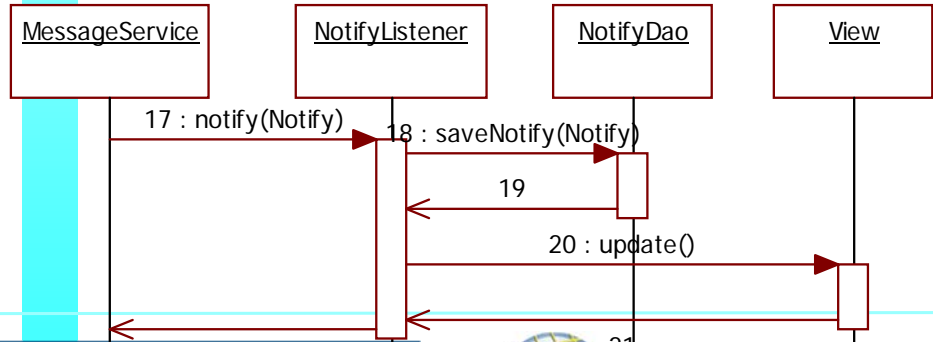
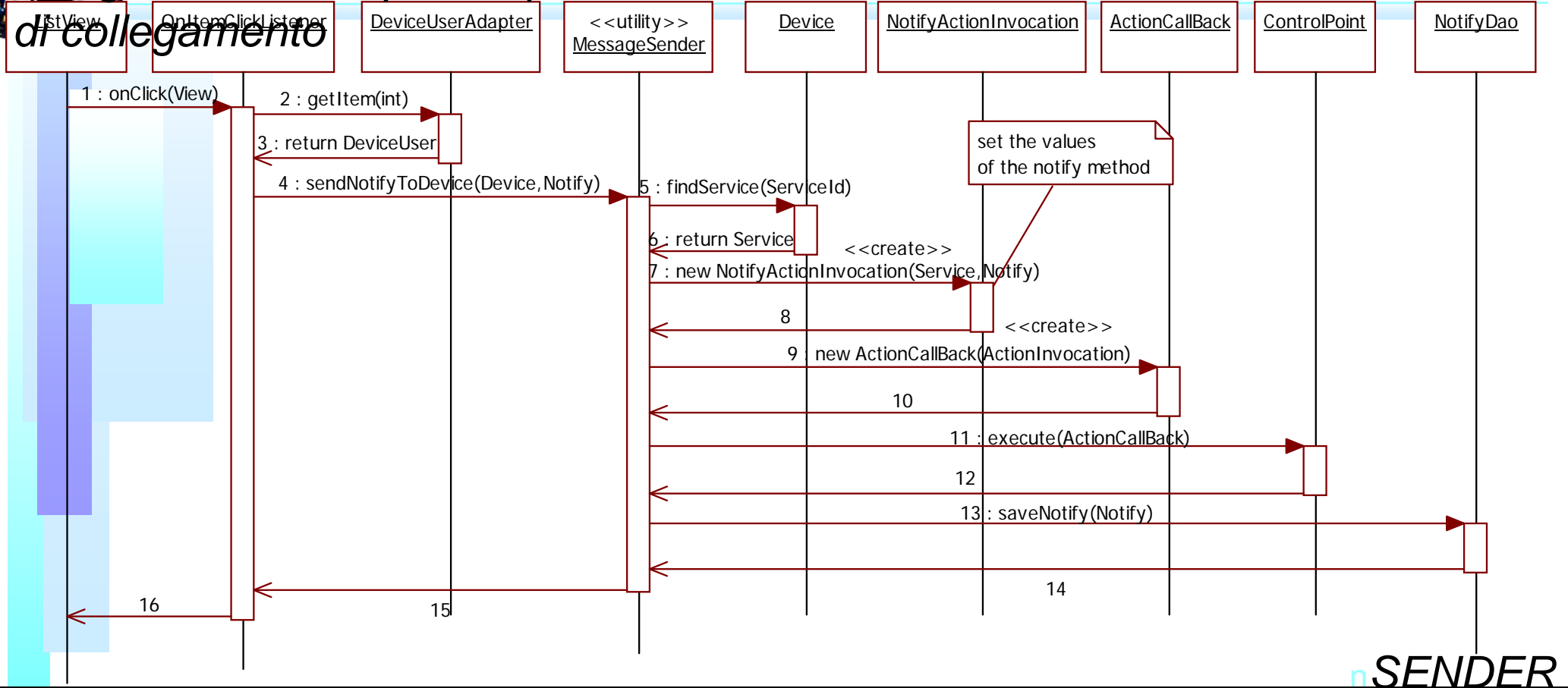

RECEIVER



Sommario

- | Problematiche dei sistemi mobili
- | Confronti fra SO e modelli di sviluppo
- | Distribuzione di contenuti per sistemi mobili
- | Modello di Programmazione iPhone
 - ♣ Si veda slide separate Parte 7a
- | Modello di Programmazione Android
- | Mobile Medicine
 - ♣ Windows Mobile
 - ♣ iPhone/iPad
 - ♣ Android
- | Content Organizer
- | Mobile Emergency
- | Mobiles and Sensors

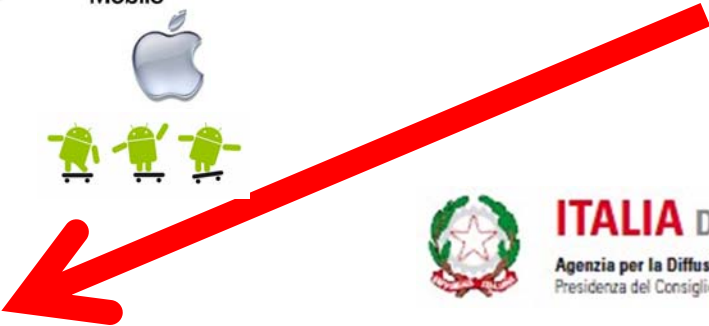

ITALIA DEGLI INNOVATORI
Agenzia per la Diffusione delle Tecnologie per l'Innovazione
Presidenza del Consiglio dei Ministri



ITALIA DEGLI INNOVATORI
Agenzia per la Diffusione delle Tecnologie per l'Innovazione
Presidenza del Consiglio dei Ministri



Mobile
Emergency

*Nuove Tecniche per la
comunicazione:*

Mobile Emergency

*Sviluppato in collaborazione con
Ospedale di Careggi, e il Lab DISIT UNIFI*



*nSistemi Distribuiti, Univ. Firenze, Paolo
Nesi 2013-2014*



Benefici

- **Migliorare il coordinamento** e l'organizzazione del personale medico e non, creare gruppi di intervento sul singolo
 - segnalare tramite smartphone la presenza di un guasto/emergenza di un problema all'interno dell'edificio,
 - Informare il personale dello stato dell'emergenza, e/o della sua occorrenza,
 - Richiamare e richiedere supporto immediato del personale di altre aree
 - essere guidati verso il luogo dell'intervento/emergenza.
- **Facilitare l'accesso all'informazione** logistica e operativa
 - Facilitare l'identificazione delle vie di fuga e dei punti di interesse, anche in modo dinamico
- ***in qualche misura* anche in assenza di connessione**

Obiettivi

- ▣ **Utilizzo di soluzioni mobili per la semplificazione della comunicazione durante le emergenze negli ospedali e in grandi strutture**
- ▣ **Ridurre i tempi di intervento e di comunicazione**
 - gestione di interventi di emergenza e manutenzione e all'interno di ospedali e/o grandi aree tramite sistemi mobili
 - gestire le mappe di una struttura ospedaliera offrendo la possibilità di indicare e memorizzare la posizione di: estintori, kit medici, scale, uscite di sicurezza, strumenti, attrezzature, aree di raccolta, ...
 - aiutare il personale a raggiungere tali elementi navigando in modo efficiente all'interno della struttura

La Soluzione

Available on the
App Store

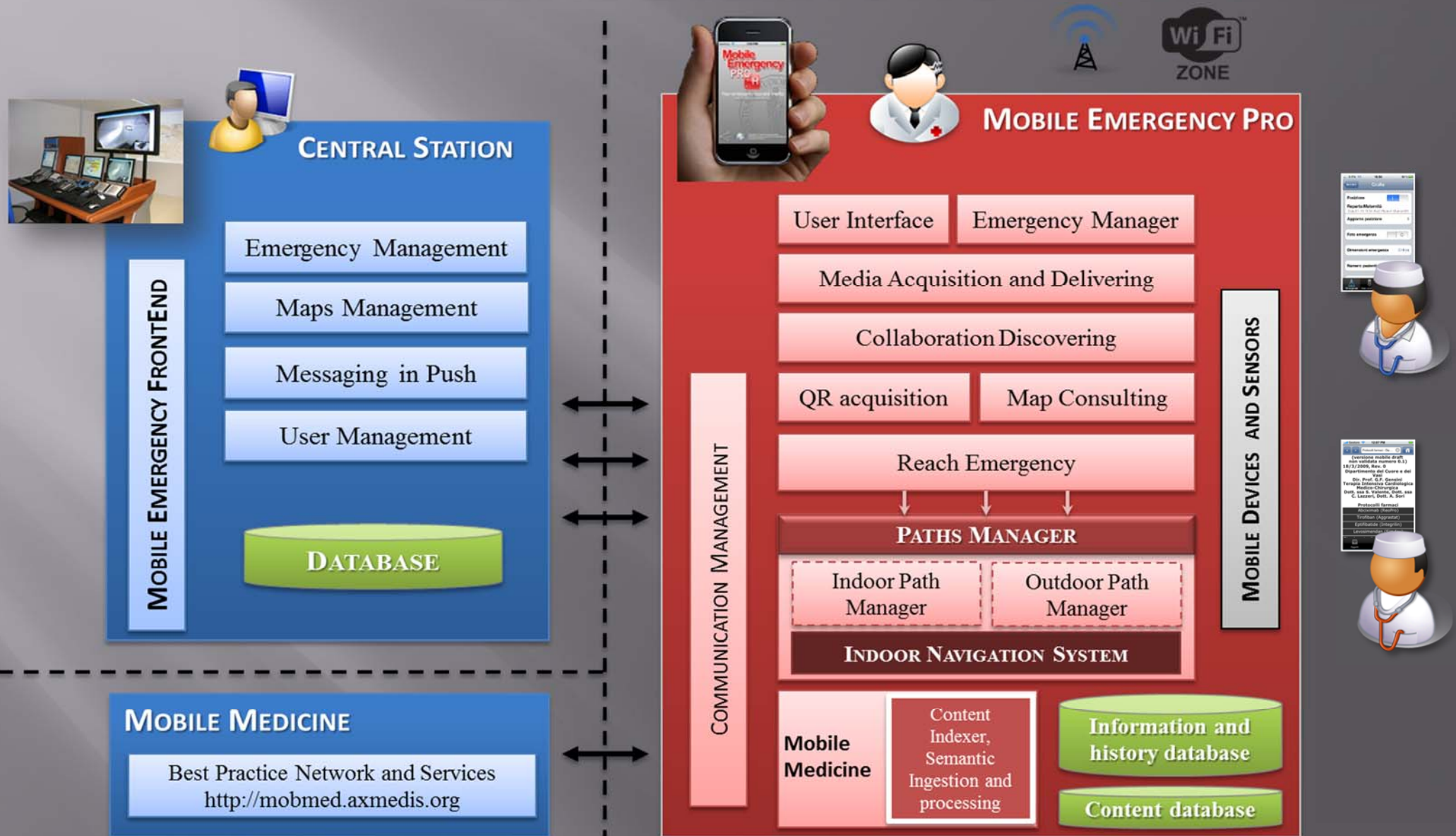

Nella Sostanza



▣ Applicazione mobile

- Fornisce il sistema di navigazione per identificare punti di interesse, uscite aree di raccolta, etc.
- Permette di raccogliere eventi di emergenza: info + foto, video
- Aiuta a trovare I colleghi e prendere contatto
- Tiene le mappe e chiede aggiornamenti
- Comunica costantemente posizione e stato con la centrale
- Fornisce manuali e procedure
- ...

▣ Centrale di Supporto:

- Gestisce e tiene Traccia delle emergenze
- Invia le squadre si intervenendo fornendogli informazioni precise e di navigazione
 - Supporta e coordina, manda messaggi in push
- Inoltre va una certo numero di azioni tecniche:
 - Gestisce ed eroga le mappe aggiornate

Mobile Emergency

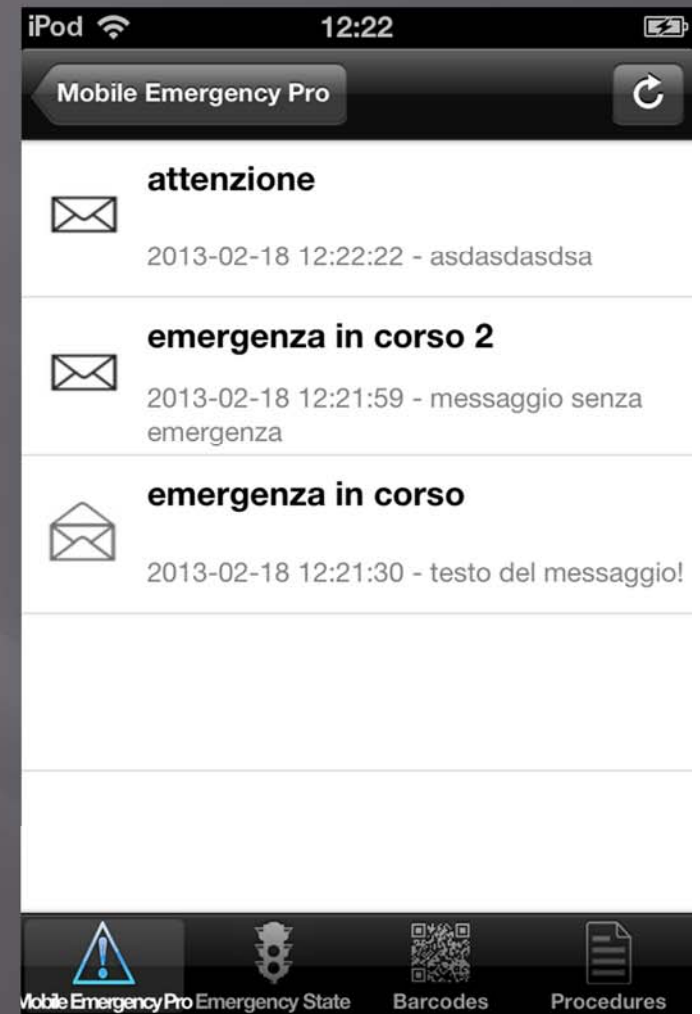
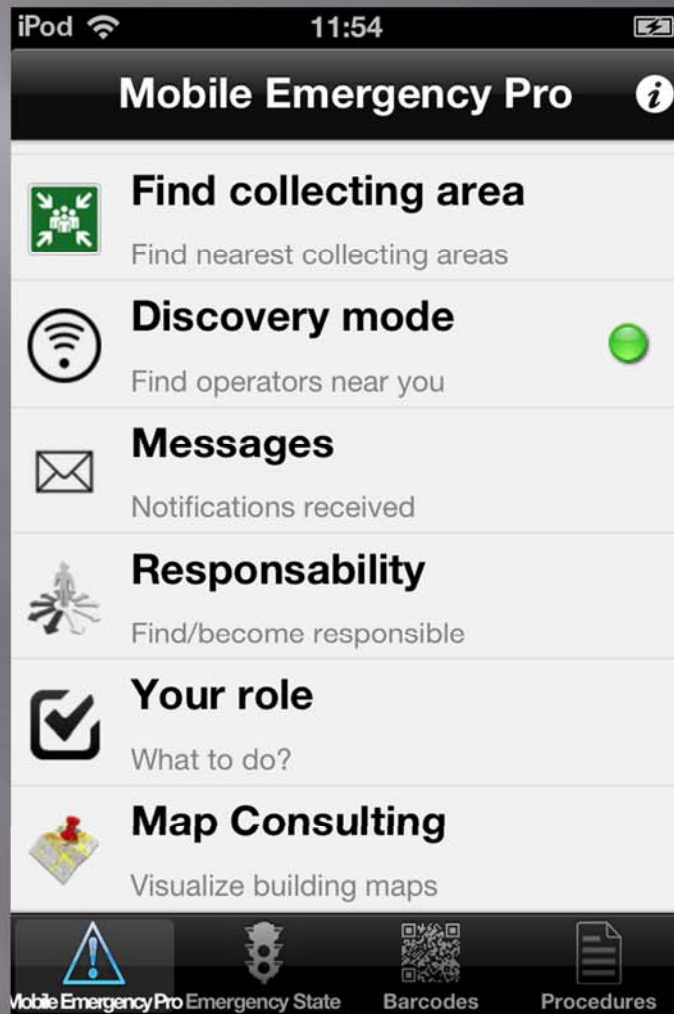
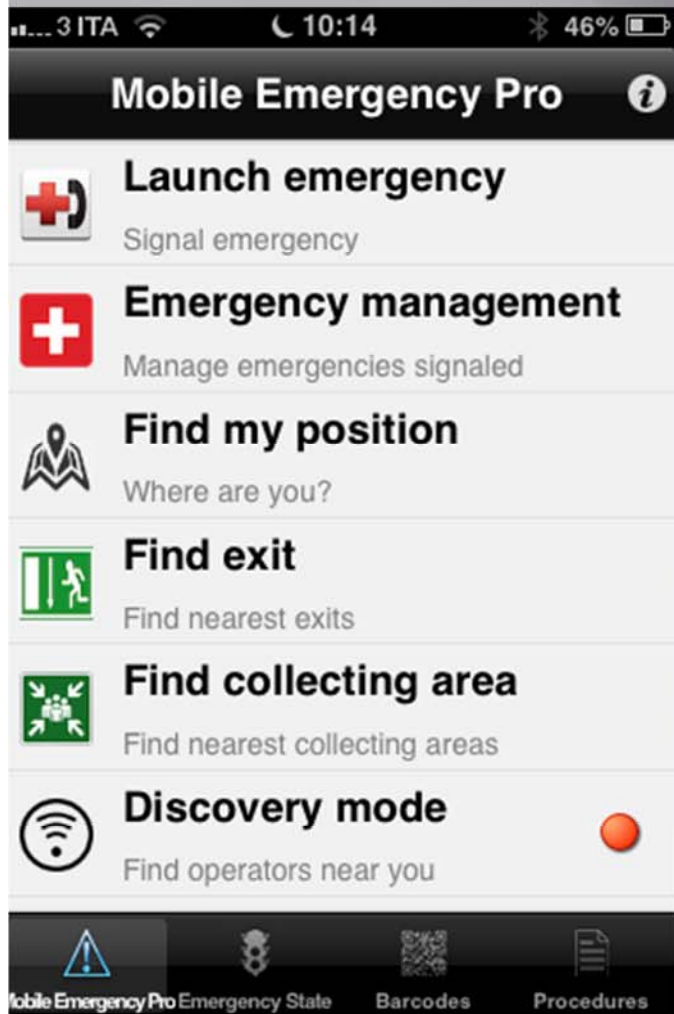

Mobile Emergency

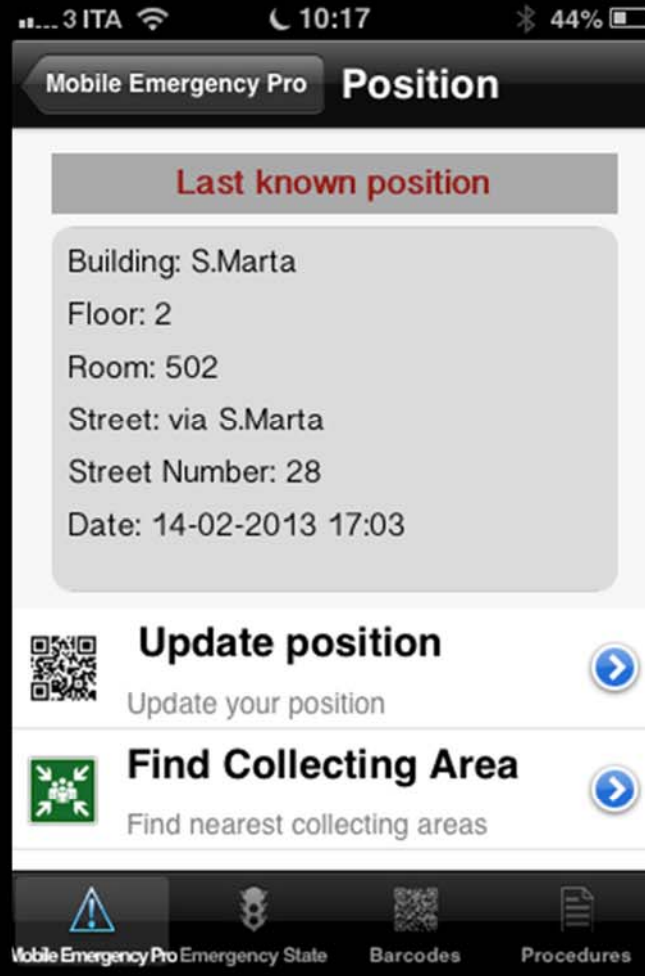

Navigazione Indoor/outdoor



12.1

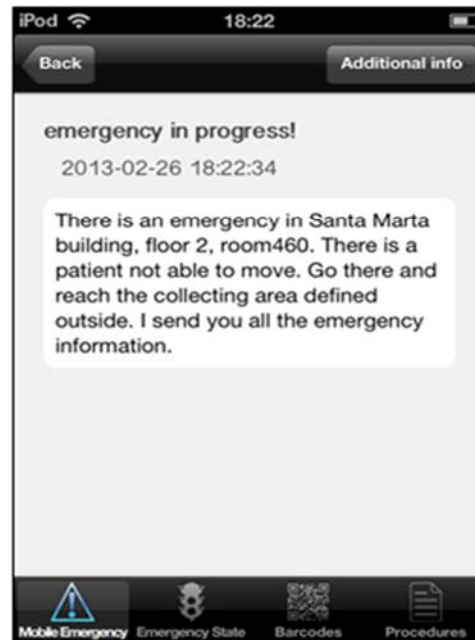

12.2



12.3



12.4

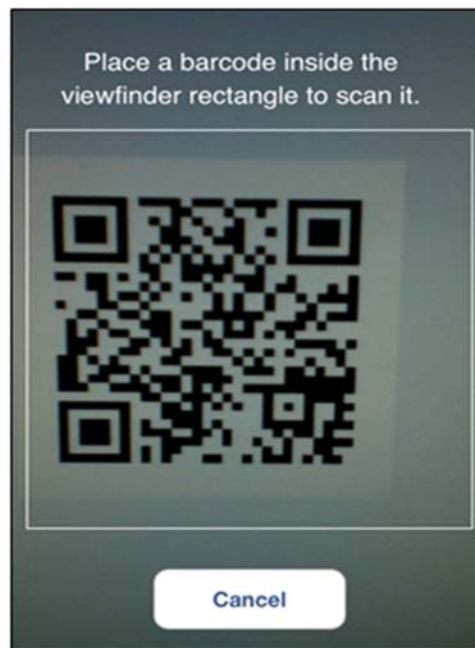

12.5



12.6

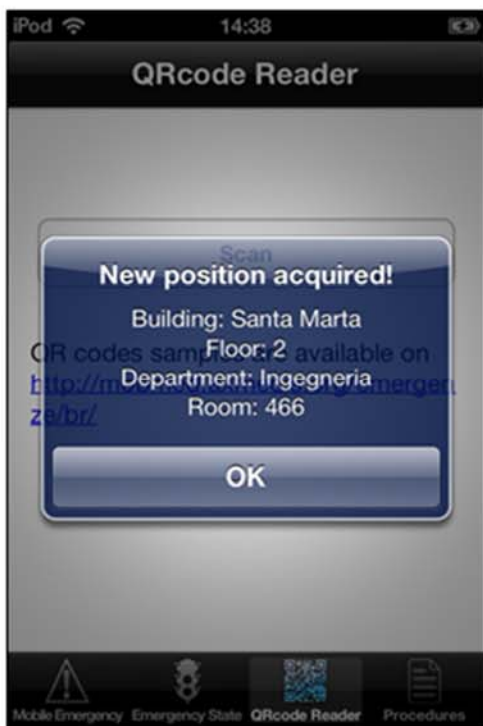

13.1



13.2



13.3

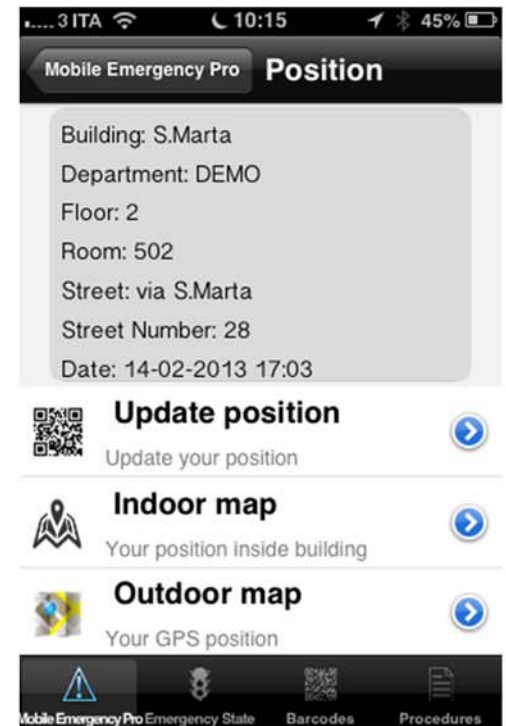

14.1



14.2



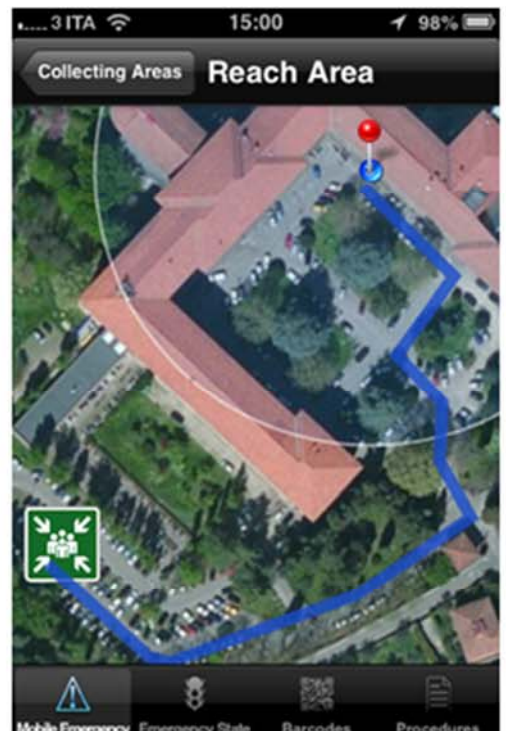

14.3



Recuperare la Posizione

Mobile
Emergency

- ▣ Soluzione integrata: GPS, QR, WiFi

QR code aspect	Description and meaning of the QR code for location, an example	Map provided to standard QR readers
	<p>“00039”: position identifier of QR “n”: control code based on SHA-1 algorithm. String BarCode: http://mobmed.axmedis.org/me/ID00039n</p>	

Informazioni e supporti

AXPDAPlayer (versione mobile draft non validata numero 0.1)
18/3/2009, Rev. 0

Dipartimento del Cuore e dei Vasi
Dir. Prof. G.F. Gensini
Terapia Intensiva Cardiologica
Medico-Chirurgo
Dott. ssa S. Valente,
Lazzeri, Dott. A.

Farmaco: Abciximab
Nome commerciale: ReoPro

Protocolli farmaceutici
Calcolo dosaggio del ReoPro in bolo (in ml)
Dose 0,25 mg / kg
Fiale non diluite (fiale da 10 mg in 5 ml)

Abciximab (ReoPro) Kg 67

Tirofiban (Aggrastat) Kg 67

Eptifibatide (Integrin) Kg 67

Levosimendan (Simvastatin) Kg 67

Bicarbonato di sodio (Bicarbocid) Kg 67

File

AXPDAPlayer

Farmaco: Abciximab
Nome commerciale: ReoPro

Protocolli farmaceutici
Calcolo dosaggio del ReoPro in bolo (in ml)
Dose 0,25 mg / kg
Fiale non diluite (fiale da 10 mg in 5 ml)

Kg 67

Calcola

1 2 3 4 5 6 7 8 9 0

! @ # \$ % & * ? /

View



AXPDAPlayer

Classificazione Neurologica Standard dei Traumi Midollari

MOTORIO: MUSCOLI CHIAVE

Inserire un valore da 0 a 5 oppure lasciare la cella vuota se non valutabile.
0 = paralisi totale
1 = contrazione palpabile o visibile
2 = movimento in assenza di resistenza
3 = movimento con gravità
4 = movimento contro parziale resistenza
5 = movimento con forza normale

Cella vuota = Not Testable (Non valutabile)

D	S	Flessione
C5		
C6		

SENSITIVO: PUNTI SENSITIVI CHIAVE (3/3)

Sensibilità Tattile Superficiale		Sensibilità Dolorifica	
D	S	D	S
L1			
L2			

AXPDAPlayer

SENSITIVO: PUNTI SENSITIVI CHIAVE (3/3)

Sensibilità Tattile Superficiale		Sensibilità Dolorifica	
D	S	D	S
L1			
L2			

File 2014-2014 View

Adobe Reader LE

CONTROPULSAZIONE INTRA-AORTICA

IN TERAPIA INTENSIVA

Modalità di gestione dello IABP in UTIC

1/35

Strumenti Menu

AXPDAPlayer

"Contropulsazione intra-aortica in US e in non-US: risultati del Registro Europeo"

Mortalità intra-ospedaliera a tutte le cause

- 10,8% US
- 18% non-US

Complicanze correlate ad IABP

- Mortalità correlata ad IABP: - 0,65% US, - 0,97% non-US
- Ischemia miocardica: - 0,9% US, - 0,8% non-US
- Stroke: - 0,9% US, - 0,8% non-US

La frequenza di complicanze correlate ad IABP è bassa sia nel centro US che nel centro non-US



AXPDAPlayer

Calcolo GFR (Creatinina)

età 56

peso (Kg)

creatinina serica

donna?

Calcola

GFR = ?

1 2 3 4 5 6 7 8 9 0

! @ # \$ % & * ? /

1/2 , ; : . ABC

File View

AXPDAPlayer

(versione draft, non approvata/validata)

DAI DEA e Medicina e Chirurgia Generale e di Urgenza
SOD Osservazione Breve Intensiva

Scegli un farmaco!

- ADRENALINA
- AMIODARONE
- DILTIAZEM (DILZENE)
- DOBUTAMINA (DOBUTAN)
- DOPAMINA (DOPAMIN)
- EPINEFRINA
- ISOSORBIDE DINITRATO (ISOSORBIDE)

File

AXPDAPlayer

Adrenalina: fiale 1 mg/1ml

Diluizione: 1 mg in 10 ml di SF o G5

Dose iniziale: 1-2 mcg/min=1-2 ml/h

P. volumetrica

Diluizione: 1f in 250 ml di SF o G5 (1ml=4mcg)

Dosaggio iniziale: 1-2 mcg/min=15/30 ml/h

File View

NOTIFICHE

33 - [EMERGENZE CHE ANCORA NON HANNO RESPONSABILE](#)1 - [EMERGENZE NON ANCORA CHIUSE](#)23 - [EMERGENZE NON ANCORA NOTIFICATE](#)





















LEGENDA

 Clicca su l'icona o sul tasto invia notifica per inviare le notifiche ai dottori in servizio.

 Visualizza i dettagli dell'emergenza.

Raggruppa

VISUALIZZA EMERGENZE: [Attive](#) - [Annullate](#) - [Rientrate](#)

	+INFO	TIPOLOGIA	UBICAZIONE	RESPONSABILE	NOTIFICHE PUSH	AGG.	DATA SEGN.	DATA CHIUS.
<input type="checkbox"/>		TERREMOTO	REPARTO: ANATOMIA 10A_0 AULA MAGNA	<u>NON ANCORA ASSEGNATO</u>	 2013-05-11 17:26:06	1	2011-05-13 17:25:50	2013-05-11 17:40:46
<input type="checkbox"/>		TERREMOTO	REPARTO: CHIRURGIE UNIVERSITARIE 8B_0 AULA MAGNA	<u>NON ANCORA ASSEGNATO</u>	 INVIA NOTIFICA	1	2011-05-13 16:26:03	2013-05-11 17:18:49
<input type="checkbox"/>		EARTHQUAKE	REPARTO: ANATOMIA 10A_0 AULA MAGNA	<u>NON ANCORA ASSEGNATO</u>	 2011-05-11 16:52:19	1	2011-05-11 16:49:26	2013-05-11 09:49:16
<input type="checkbox"/>		EARTHQUAKE	REPARTO: CHIRURGIE UNIVERSITARIE 8B_0 AULA MAGNA	<u>NON ANCORA ASSEGNATO</u>	 2011-05-11 16:14:56	1	2011-05-11 16:14:27	2013-05-11 09:49:19
<input type="checkbox"/>		EARTHQUAKE	REPARTO: ANESTESIA ANESTESIA B 3 ANE02	<u>NON ANCORA ASSEGNATO</u>	 2011-05-11 16:04:55	1	2011-05-11 16:03:21	2013-05-11 09:49:22
<input type="checkbox"/>		FIRE	REPARTO: ANESTESIA PEDIATRIA C 3 PED04	<u>NON ANCORA ASSEGNATO</u>	 INVIA NOTIFICA	1	2011-05-09 18:11:11	2013-05-11 09:49:25
<input type="checkbox"/>		INCENDIO	REPARTO: ANESTESIA ANESTESIA B 3 ANE02	PIERFRANCESCO BELLINI 333...	 INVIA NOTIFICA	1	2011-04-28 18:46:05	2013-05-11 09:49:28
<input type="checkbox"/>		INCENDIO	REPARTO: ANESTESIA ANESTESIA B 3 ANE02	<u>NON ANCORA ASSEGNATO</u>	 2028-04-11 18:43:42	1	2011-04-28 18:43:14	2028-04-11 18:45:37
<input type="checkbox"/>		INCENDIO	REPARTO: ANESTESIA ANESTESIA B 3 ANE02	<u>NON ANCORA ASSEGNATO</u>	 INVIA NOTIFICA	1	2011-03-24 17:53:25	2028-04-11 18:41:54
<input type="checkbox"/>		INCENDIO	REPARTO: ANESTESIA ANESTESIA B 3 ANE02	<u>NON ANCORA ASSEGNATO</u>	 INVIA NOTIFICA	1	2011-03-19 17:00:18	2028-04-11 18:40:00

Valutazioni dalle Simulazioni sul campo

Mobile
Emergency

	Con Mobile Emergency		Senza	
	Valore medio	SD	Valore medio	SD
Tempo di chiamata (sec)	48,67	2,30	57,33	6,80
Qualità della chiamata (score)	4,98	0,05	3,66	0,22
Tempo necessario a partire verso la sede dell'emergenza (min:sec)	1:58	0:07	1:02	0:15
Tempo per raggiungere l'emergenza da parte del team (min:sec)	4:19	0:34	12:58	6:33
Tempo totale di intervento (senza il tempo di azione e gestione del paziente), min:sec	9:57	0:57	16:20	7:05

Mobile emergency

Mobile
Emergency

- ▣ Si sta cercando di passare a realizzare un trial esteso
- ▣ Dalle valutazioni:
 - Riduce il Tempo necessario per raggiungere la posizione di emergenze, punti di intervento, vie di fuga, etc.
 - Semplifica le comunicazioni e le gestisce
 - Permette di tenere traccia e di gestire lo stato del personale sul territorio
 - ...

Progettazione della UI

Mobile
Emergency



STATO CONNESSIONE
- Verde = disponibile
- Rosso = non disponibile

1. IDENTIFICAZIONE UTENTE

Identificazione Utente

CONFIRMA

Legenda:

- ⚠ : sezione Emergenza
- 📶 : sezione Stato Emergenza
- 📄 : sezione Procedure
- 📍 : sezione Posizione
- 💬 : sezione Chat

2. SEGNALAZIONE EMERGENZA

Emergenza

segnala emergenza

revoca emergenza

2,4 SEGNALAZIONE EMERGENZA (TIPO)

Tipo Emergenza

INCENDIO

TUMULTO

ALLA CARICATA

3. RICERCA EMERGENZA

Emergenza

Segnala Emergenza

revoca Emergenza

LETTURA / 4. INVIO BARCODE

Invio Barcode a caso

5. INVIO FOTO/VIDEO

SCATTO / 5. INVIO FOTO/VIDEO

INVIA

ROLL

6. CHAT

CHAT

Invia

8. RICHIESTA VIA PIU' CORTA

7 6 5

4

1 2 3

7. RICHIESTA PROCEDURA

Procedure

Procedura 4

Procedura 2

9. RICHIESTA DISINNEBBIAZIONE AREA DI RACCOLTA

RACCOLTA

ROSSA	20m
VERDE	50m
GIALLA	120m
ROSSA	300m
GIALLA	220m

10. RICHIESTA PERICOLO AREA DI RACCOLTA

AR

1 2 3 4 5 6

Diagramma delle classi

Mobile
Emergency

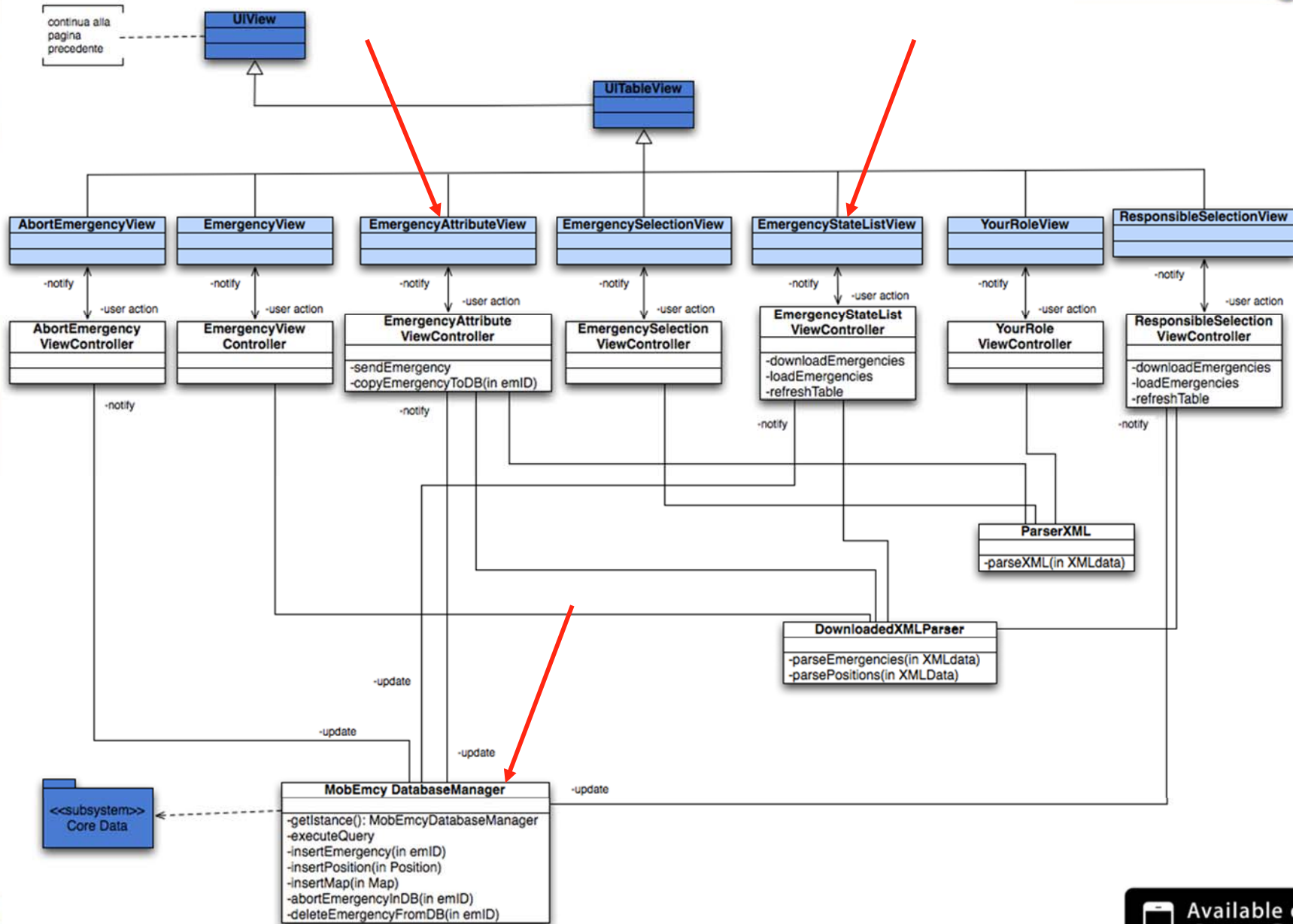



Diagrammi di sequenza

Mobile
Emergency

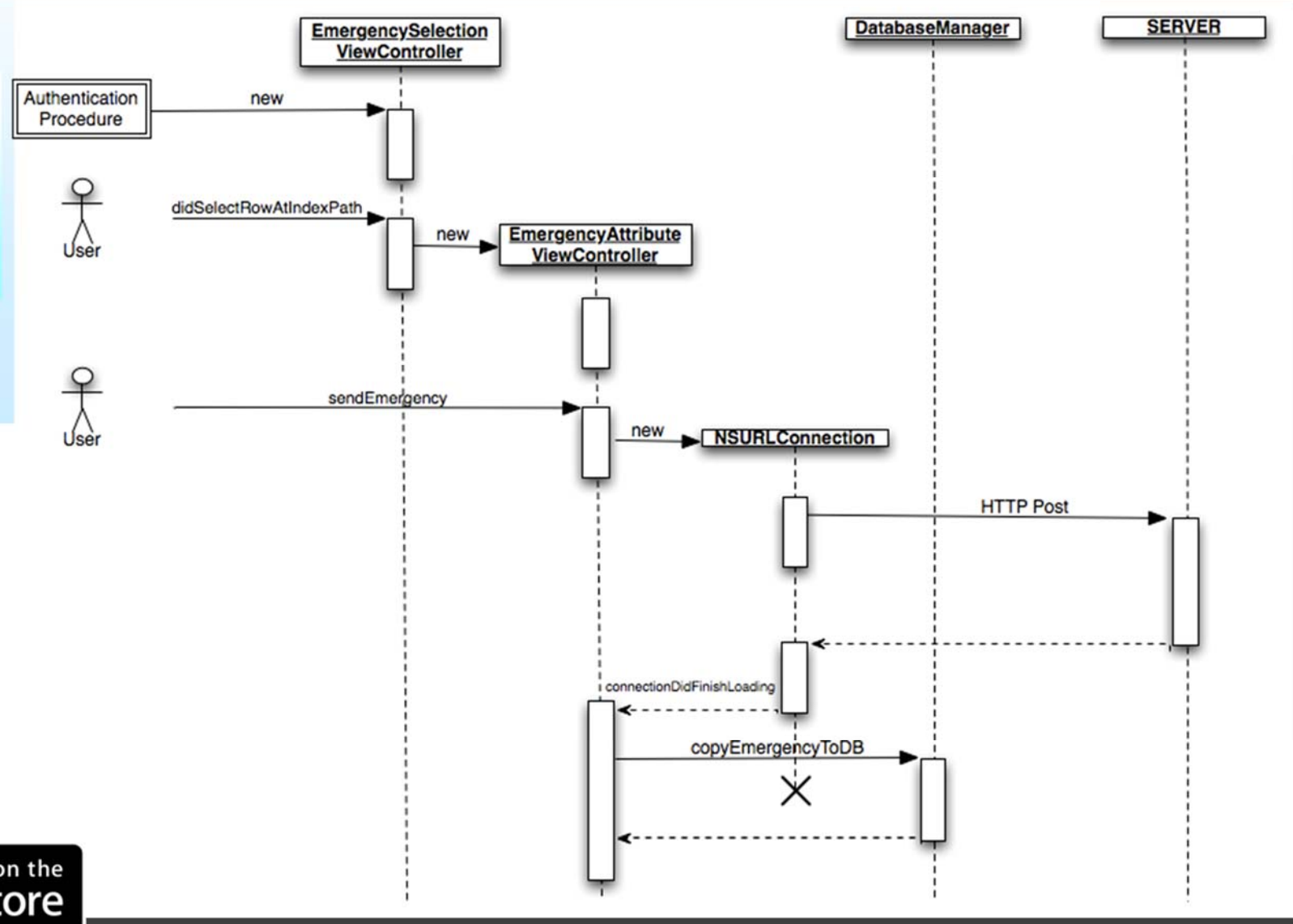

Segnalazione di una situazione di emergenza



Diagrammi di sequenza

Mobile
Emergency

Available on the
App Store

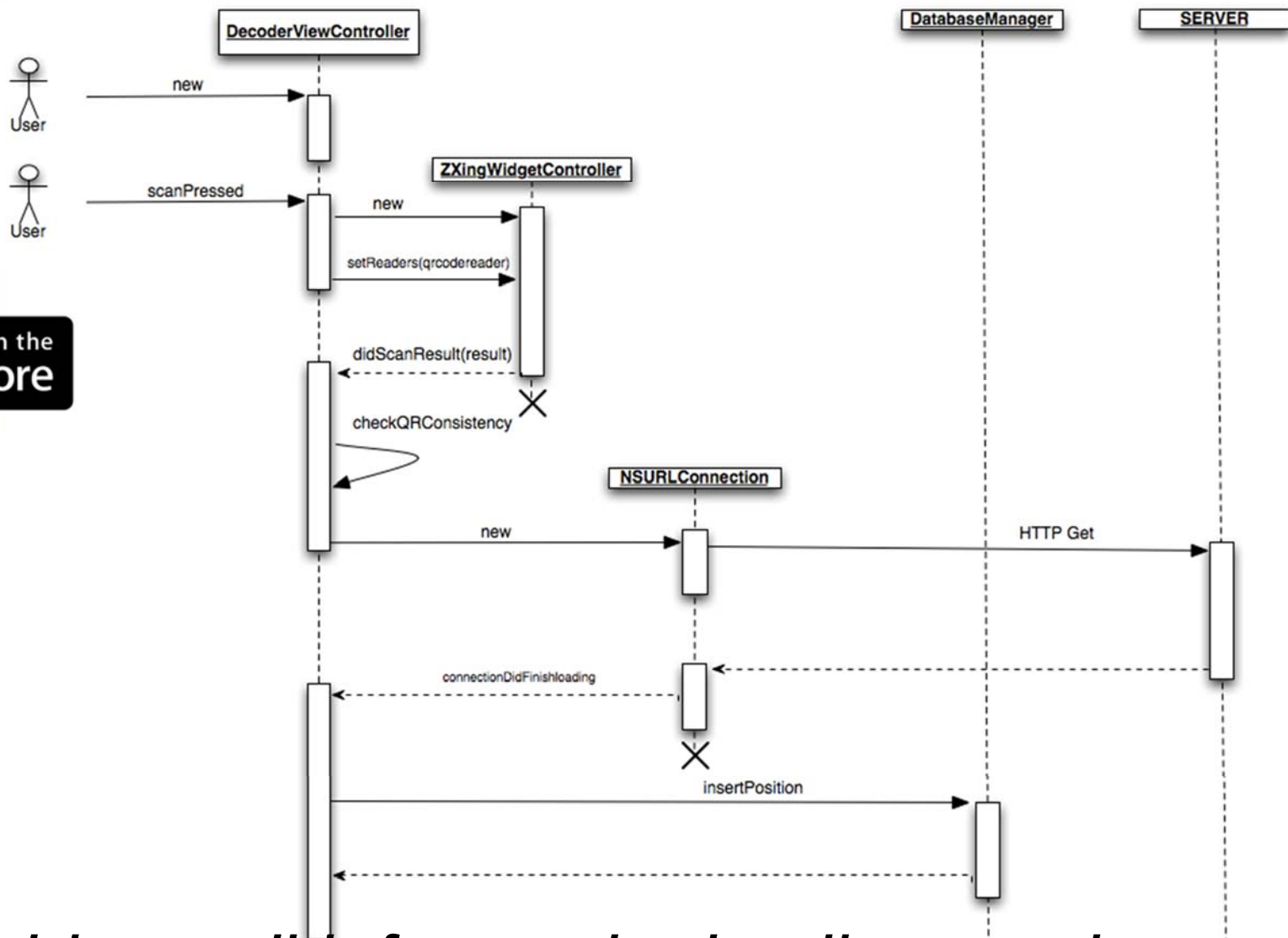

n Richiesta di informazioni sulla propria posizione

La base di dati

Mobile
Emergency

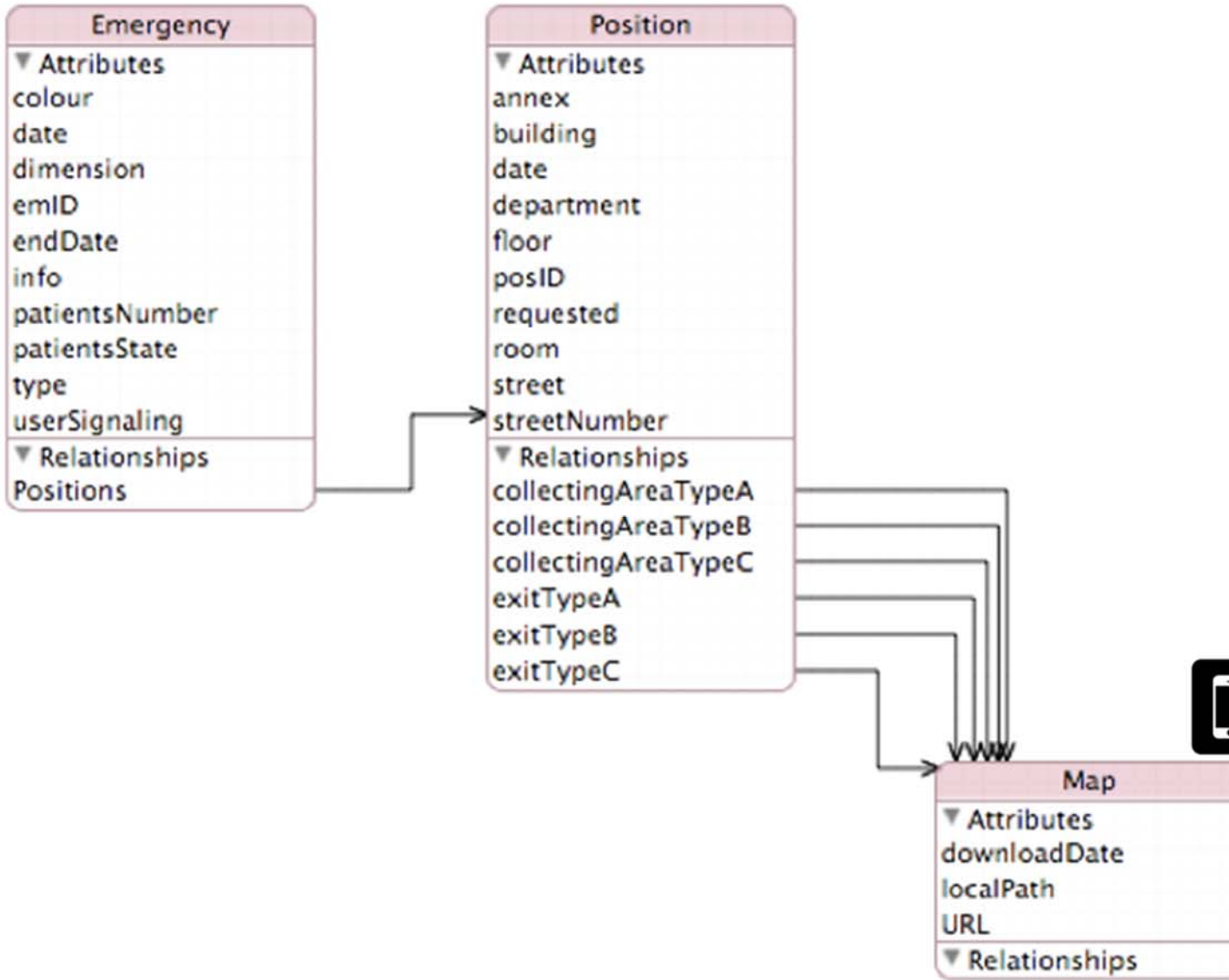

Available on the
App Store



Comunicazione Client / Server

Mobile
Emergency

*Comunicazioni tra dispositivi e Centrale Operativa
tramite connessioni HTTP con richieste POST e GET
(NSURLConnection)*

*Informazioni inviate dalla Centrale Operativa ai
dispositivi sotto forma di contenuti XML*

```
n<posizione>
n    <id_posizione>107</id_posizione>
n    <via>Via S. Marta</via>
n    <numero>3</numero>
n    <edificio>3</edificio>
n    <ala>OVEST</ala>
n    <piano>2</piano>
n    <stanza>123</stanza>
n    <reparto>Psicologia</reparto>
n    <uscita_A>.../emergenze/images/qr/107/uscita1.png</uscita_A>
n    <uscita_B>.../emergenze/images/qr/107/uscita2.png</uscita_B>
n    <uscita_C></uscita_C>
n    <area_raccolta_A>.../images/qr/107/uscita1.jpg</area_raccolta_A>
n    <area_raccolta_B>.../images/qr/107/uscita2.jpg</area_raccolta_B>
n<area_raccolta_C></area_raccolta_C>
n</posizione>
```



Le Notifiche Push

Mobile
Emergency

Notifiche push utilizzate per la propagazione dell'informazione durante le situazioni di emergenza



I dispositivi interessati vengono raggiunti dalla Centrale Operativa in pochi secondi

Funzionamento Notifiche Push:

Centrale Operativa APNS

Applicazione Mobile Emergency

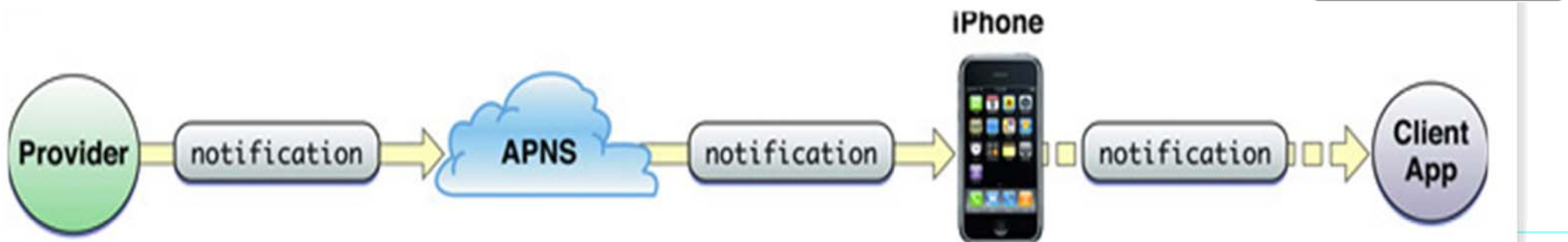

Sommario



- | Problematiche dei sistemi mobili
- | Confronti fra SO e modelli di sviluppo
- | Distribuzione di contenuti per sistemi mobili
- | Modello di Programmazione iPhone
 - ♣ Si veda slide separate Parte 7a
- | Modello di Programmazione Android
- | Mobile Medicine
 - ♣ Windows Mobile
 - ♣ iPhone/iPad
 - ♣ Android
- | Content Organizer
- | Mobile Emergency
- | Mobiles and Sensors



ITALIA DEGLI INNOVATORI
Agenzia per la Diffusione delle Tecnologie per l'Innovazione
Presidenza del Consiglio dei Ministri



ITALIA DEGLI INNOVATORI
Agenzia per la Diffusione delle Tecnologie per l'Innovazione
Presidenza del Consiglio dei Ministri



Mobile Devices vs Sensors



- | + thermometer
- | + RFID
- | +

Segmento spaziale

Composto da una costellazione di 31 satelliti (con ridondanza)

- I satelliti (nella configurazione originale) sono disposti su 6 orbite:
 - spaziate tra loro di 60° gradi
 - inclinate di 55° rispetto al piano equatoriale
 - disposte su diverse quote (~ 20.000 km da terra)
 - il periodo orbitale è di 12 ore siderali (corrispondenti a 11h 56m)
 - in qualsiasi **momento** e **posizione** sono visibili 4-12 satelliti
- Satellite:
 - ~ 7 anni di vita
 - 4 orologi atomici
- satellite trasmette a terra dati (a 50 bit/s):
 - Contengono varie informazioni tra cui un segnale di tempo e informazioni sulla propria orbita (***effemeridi orbitali***) e su quella degli altri satelliti (***almanacco***)

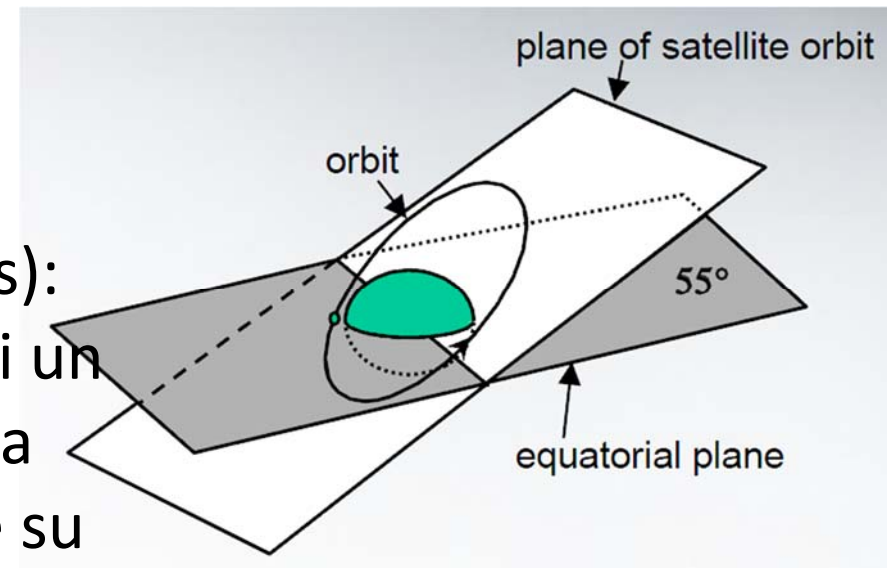

Sistemi GPS

- Sistema planetario con 31 satelliti che orbitano a circa 26 560 km
- Permette il posizionamento sulla base della ricezione di almeno 3 satelliti, 4 o + per aumentare la precisione
 - 5 o + sono sempre visibili da ogni punto.
- Stima per triangolazione.
- Errore Max: alcuni metri
 - Correzioni di rel. ristretta e generale
- Nuovi sistemi → minore errore

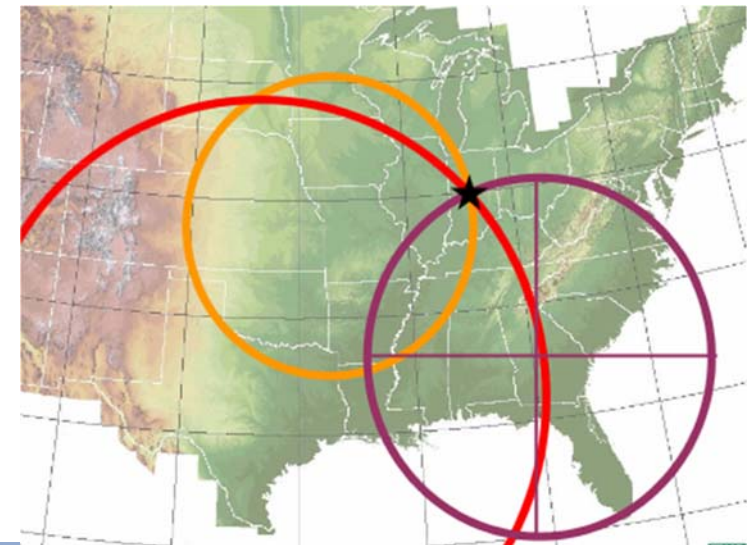
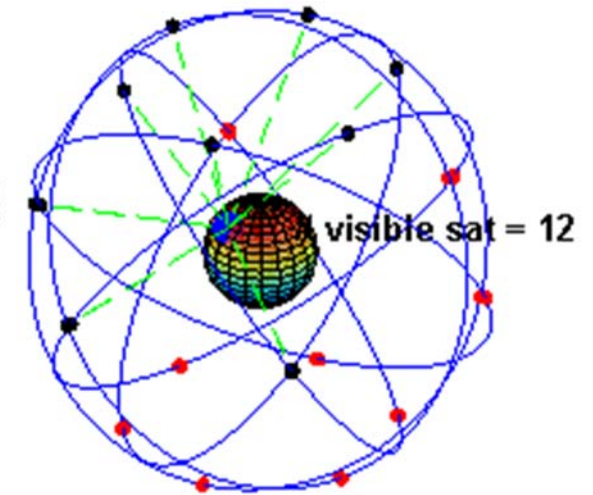

La correttezza della trilaterazione dipende da una perfetta sincronizzazione tra gli orologi: un millesimo di secondo può penalizzare la localizzazione nell'ordine dei 300 km!!!

- Nel caso generale, le incognite del sistema sono 4:
 - Latitudine
 - Longitudine
 - Altitudine
 - Errore temporale (l'orologio del satellite e quello del ricevitore non sono perfettamente sincronizzati)
- Sono quindi necessari almeno 4 satelliti per localizzare un ricevitore GPS in uno spazio 3D
- 3 satelliti sono sufficienti nel caso in cui l'altitudine sia nota (es. Nella navigazione, altitudine = 0)

A-GPS permette di abbattere i tempi necessari alla prima localizzazione (fixing)

- Il ricevitore recupera l'informazione relativa al posizionamento dei satelliti (ricercare i satelliti in vista fra i 31 possibili); questa operazione è onerosa in termini di tempo e risorse, scansione delle frequenze mediante GPRS o UMTS
- Tale metodologia si appoggia sull'utilizzo della rete cellulare (quindi su un operatore di telefonia mobile)
- Il sistema cellulare scarica periodicamente l'informazione corretta sul posizionamento dei satelliti

Navigazione Inerziale

- La navigazione inerziale e' l'unica possibile in assenza di ricezione di segnale GPS. Per esempio sott'acqua, nelle abitazioni, in galleria, etc.
- Per **navigazione inerziale** si intende un sistema che
 - permetta di navigare in un ambiente in modo sufficientemente accurato da raggiungere un obiettivo prefissato a partire da un punto di partenza senza utilizzare riferimenti assoluti di posizione come GPS.

Sensori su sistemi Mobili

- Gli attuali sistemi mobili possono avere come sensori:
 - **Accelerometri**
 - Misura l'accelerazione su tre assi lineari
 - **Giroscopio/ Gyros**
 - Misura l'accelerazioni del movimento angolare
 - **Bussola/Compass**
 - Sensore del campo magnetico, sensibile fino al punto di sentire quello terrestre.
 - **Telecamera**
 - Acquisizione di immagini e video

Sensori

- GPS
- Gyroscope
- Accelerometer
- Magnetic field



sensors.Apple iPhone 4

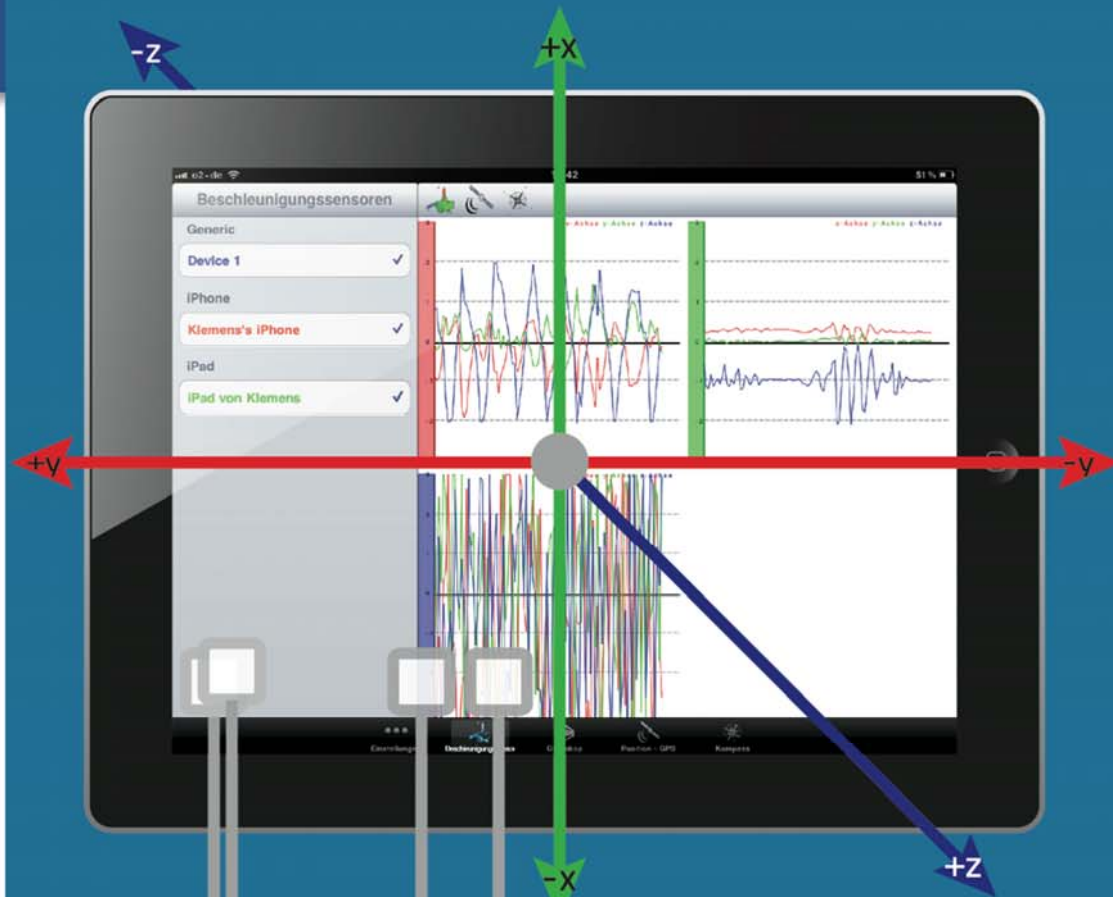

gps ±30

broadcom bc4751

gyroscope ±30

st micro agd8 2103 rad/s

magnetometer ±2mT

akm semicond.

akm 8975

accelerometer ±2G

st micro lis331dlh



UNIVERSITÀ
DEGLI STUDI
FIRENZE

DINFO
Dipartimento di
Ingegneria dell'Informazione



sensors.Apple iPad 2 3G



Accelerometro

- 3 assi
- Per la misura delle accelerazioni
 - E.g., iPhone 4 range: $\pm 2g$, precision 0.018g
 - Orientamento del cellulare
 - Sensore piezoelettrico
- Uso:
 - Navigazione inerziale
 - Interazione, shake

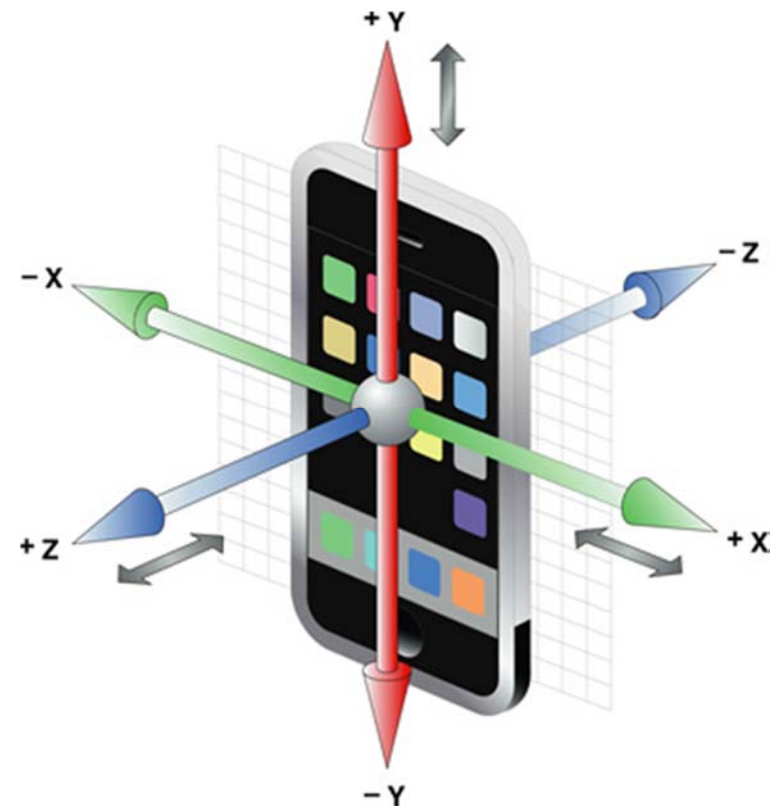

Giroscopio

- 3 assi
- Per la misura le variazioni di orientamento
 - **angular rate** expressed in rad/s on 3 axis

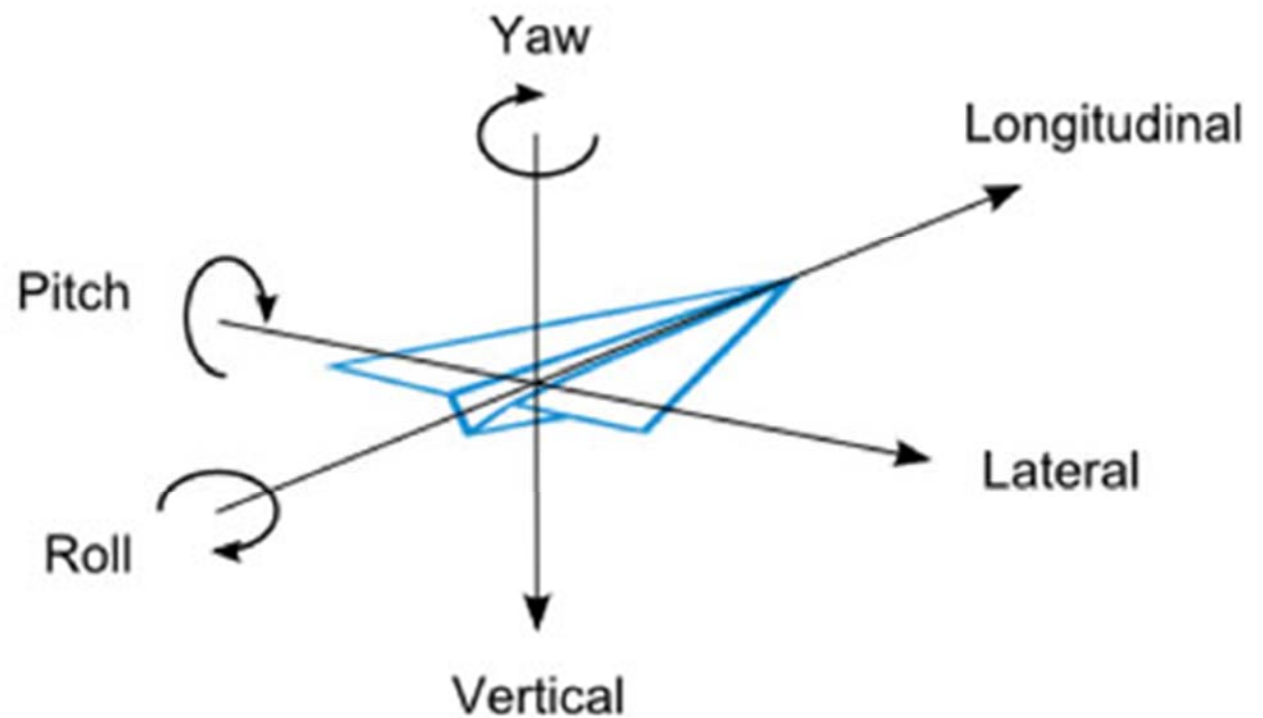

Magnetometro

- Misura la forza del campo magnetico (per esempio quello terrestre)
 - range: $\pm 2\text{mT}$ (Tesla)
- Influenzato da campi magnetici che possono creare errori molto rilevanti e in certi sensori anche persistenti

Esempio di Navigazione Inerziale

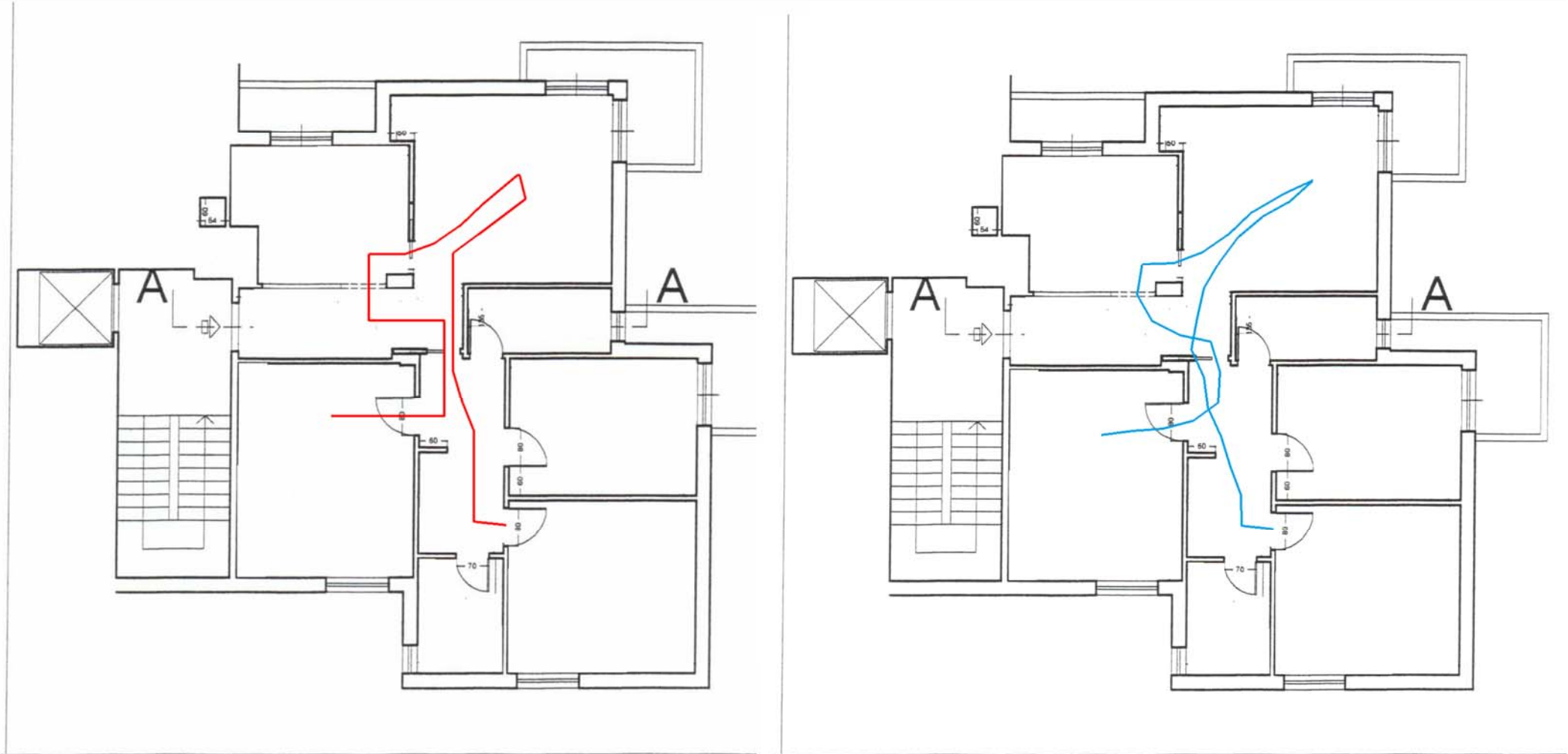

Preso da Mobile Emergecy

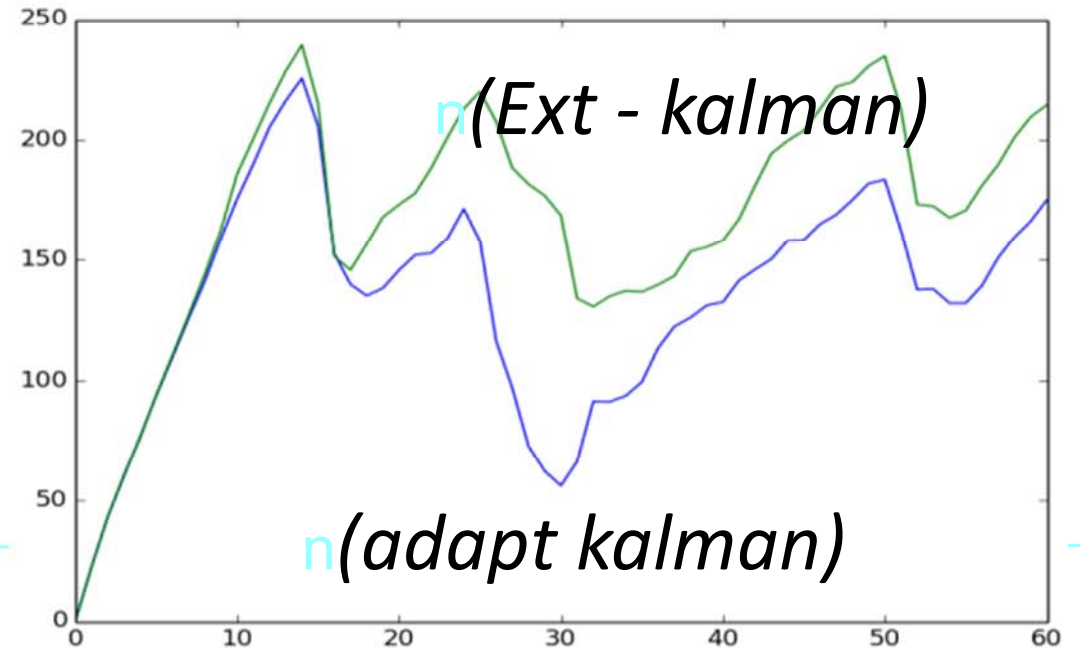
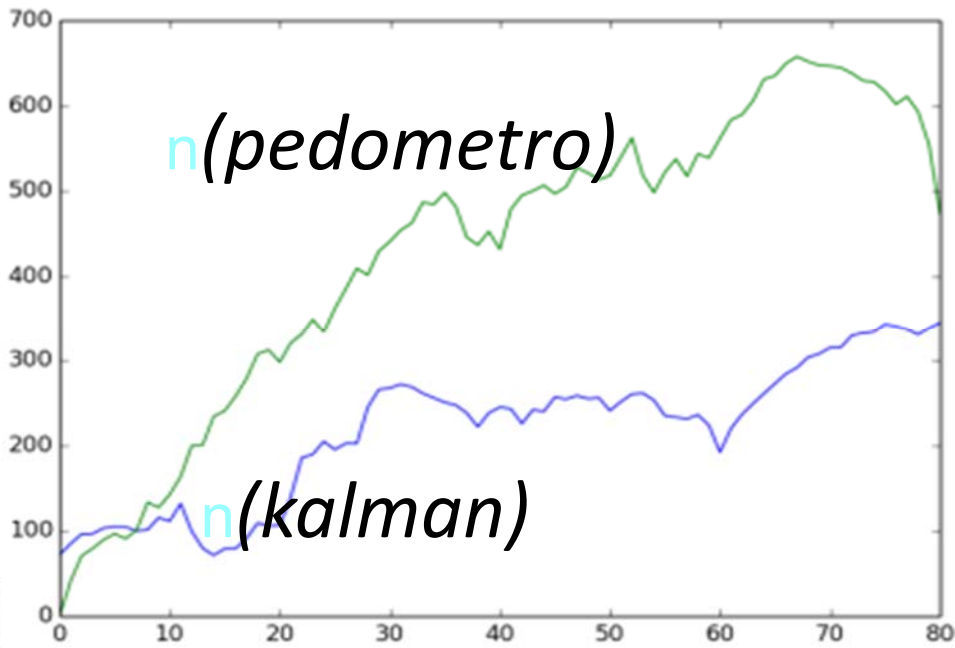
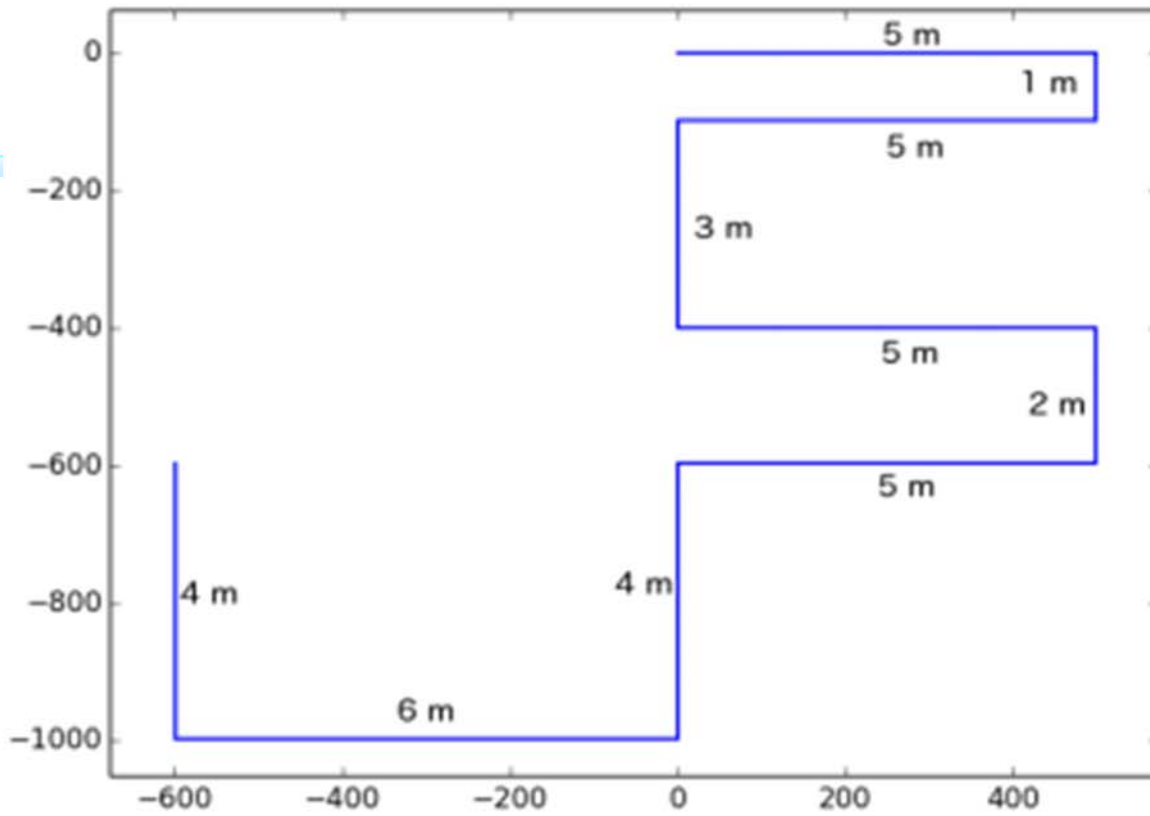



Available on the
App Store

Riferimenti



ITALIA DEGLI INNOVATORI

Agenzia per la Diffusione delle Tecnologie per l'Innovazione
Presidenza del Consiglio dei Ministri

- P. Bellini, S. Boncinelli, F. Grossi, M. Mangini, P. Nesi, L. Sequi, "**Mobile Emergency: supporting emergency in hospitals with mobile devices**", Theme Issue Media Tablets & Apps (Guest editors: Pincioli & Pagliari), JMIR RESEARCH PROTOCOLS, doi:10.2196/resprot.2293, in press, 2013.
- <http://www.disit.dinfo.unifi.it/mobemergency.html>
- **Manuale:** <http://mobmed.axmedis.org/mobempro/manual.pdf>
- **AppleStore:** <https://itunes.apple.com/us/app/mobile-emergency-pro/id580488034?mt=8>
- **Mobile Medicine** <http://mobmed.axmedis.org/>
- Video anche su: <http://www.disit.dsi.unifi.it/> e youtube.



Riferimenti



Mobile Medicine: <http://mobmed.axmedis.org>

♣ [Manuale: http://mobmed.axmedis.org/Mobile-Medicine-Manual.pdf](http://mobmed.axmedis.org/Mobile-Medicine-Manual.pdf)

♣ Strumenti di sviluppo e produzione

AXMEDIS: <http://www.axmedis.org>

♣ Report e documentazione, strumenti di sviluppo e dimostrativi

DISIT Lab, Univ. Firenze, DSI: <http://www.disit.dsi.unifi.it/>

P. Bellini, I. Bruno, D. Cenni, P. Nesi, M. Paolucci, "*Personal Content Management on PDA for Health Care Applications*", 2009 IEEE International Workshop on Semantic Computing and Multimedia Systems ([IEEE-SCMS 2009](#)), Berkeley, CA, USA - September 14-16, 2009

P. Bellini, I. Bruno, A. Fuzier, P. Nesi, M. Paolucci, "*Semantic Processing and Management for MultiChannel Cross Media Social Networking*", NEM conference, Saint Malo, France, September 2009.

P. Nesi, "[Le basi tecnologiche della Mobile Medicine](#)", Congresso SIAARTI, Firenze, Agosto 2009.

[keynote Speaker](#) for the [2nd International Symposium on Intelligent Interactive Multimedia Systems and Services](#), IIMSS2009, Hosted by University of Milan, MOgliano Veneto, 16-17 July 2009.

Riferimenti



- | <http://www.eclap.eu>
- | This slide link: <http://bpnet.eclap.eu/drupal/?q=en-US/home&axoid=urn:axmedis:00000:obj:6f371ec5-b5d5-46e5-bd5e-a10a3e4228b4>
- | ECLAP workflow and IPR wizard tools can be taken from the ECLAP user manual:
 - ♣ <http://bpnet.eclap.eu/drupal/?q=en-US/home&axoid=urn:axmedis:00000:obj:b828710e-b77c-4074-993c-3efddfbfaad7§ion=pagesupport>
- | Online manual/help:
 - ♣ http://bpnet.eclap.eu/help/eclap_bpnet_user_manual_v1-0.htm
- | Video of the Content Organizer:
 - ♣ <http://bpnet.eclap.eu/drupal/?q=en-US/home&axoid=urn:axmedis:00000:obj:ea5eb861-18b6-4262-8d4b-77b3d3c084f0>
- | ECLAP infrastructure document
 - ♣ <http://bpnet.eclap.eu/drupal/?q=en-US/home&axoid=urn:axmedis:00000:obj:a345a84f-6fdf-4f84-a412-88094ce363e2>



Riferimenti

- | P. Bellini, I. Bruno, D. Cenni, P. Nesi, "Micro grids for scalable media computing and intelligence on distributed scenarios", IEEE Multimedia, in press, IEEE Computer Soc. Press.
- | P. Bellini, I. Bruno, D. Cenni, A. Fuzier, P. Nesi, M. Paolucci, "Mobile Medicine: Semantic Computing Management for Health Care Applications on Desktop and Mobile Devices", in press on [Multimedia Tools and Applications](#), Springer.
- | P. Bellini, I. Bruno, P. Nesi, "EXPLOITING INTELLIGENT CONTENT VIA AXMEDIS/MPEG-21 FOR MODELLING AND DISTRIBUTING NEWS", [International Journal of Software Engineering and Knowledge Engineering](#), World Scientific Publishing Company, in press.

Riferimenti



- | Android Operating System, <http://source.android.com/>
- | Window Mobile, <http://www.microsoft.com/windowsmobile/it-it/default.mspx>
- | Palm OS, <http://www.palm.com/it/it/>
- | Symbian Operating System, <http://www.symbian.org/>
- | SQLite3 v3.6.12, <http://www.sqlite.org/> , 2009
- | iPhone SDK 3.2, <http://www.apple.com/it/ipad/sdk> US, 2010.
- | Alasdair A., Learning Iphone Programming: From Xcode to App Store
- | Table View Programming Guide for iPhone OS, Apple Inc.



DISIT Mobile Applications

- | Content Organizer
- | Mobile Medicine
- | Mobile Emergency
- | White Rabbit
- | Monitoring Camper
- | Parla con Me
- | Monitoraggio Pazienti
- | Gestione Emergenza treni
- |
- |
- | Samsung SmartTV



Fine MOBILE