



# Sistemi Distribuiti

## Corso di Laurea in Ingegneria

*Prof. Paolo Nesi*

*Parte 13: MPEG-21 Introduzione*

Department of Systems and Informatics

University of Florence

Via S. Marta 3, 50139, Firenze, Italy

tel: +39-055-4796523, fax: +39-055-4796363

**Lab: DISIT, Sistemi Distribuiti e Tecnologie Internet**

nesi@dsi.unifi.it, paolo.nesi@unifi.it

<http://www.disit.dsi.unifi.it/>

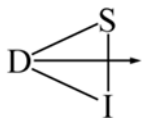

# What is MPEG-21?

- An open framework for multimedia delivery and consumption
  - ♣ many elements exist to build an infrastructure for the production, delivery and consumption of multimedia content.
  - ♣ The aim for MPEG-21 is to describe how these various elements fit together.
- Focal points:
  - ♣ Content creators
  - ♣ Content consumers



# MPEG

- MPEG is a working group of ISO
  - ♣ ISO/IEC JTC 1/SC 29/WG 11
  - ♣ Coding of moving pictures and audio
- Development of international standards for compression, decompression, processing and coded representation of moving pictures, audio, and their combination, in order to satisfy a wide variety of applications



# MPEG standards application examples

- Video CD, MP3, DVD
- Satellite TV, digital cable, HDTV
- Video on demand
- PC video streaming
  - ♣ Apple QuickTime
  - ♣ Microsoft Windows Media Player
  - ♣ RealNetworks Helix and RealPlayer
- Do-it-yourself

# The MPEG family

- MPEG-1 and MPEG-2 provide interoperable ways of representing audiovisual content, commonly used on digital media and on the air
- MPEG-4 defines how to *represent* content
- MPEG-7 specifies how to *describe* content
- MPEG-21 provides a truly interoperable multimedia framework

# MPEG-1 — ISO/IEC 11172

- Coding of moving pictures and associated audio for digital storage media
- Video and audio at 1.5M bit/s for CD-ROM
- Five parts:
  - ♣ Part 1 (systems): multiplexing & synchronization
  - ♣ Part 2 (video): ~VHS quality at 1.15M bit/s
  - ♣ Part 3 (audio): stereo at 384K, 256K, 192K bit/s
  - ♣ Part 4 (conformance testing): references for decoder
  - ♣ Part 5 (reference software): C implementation
- Applications: Video CD, MP3

# MPEG-2 — ISO/IEC 13818

- Generic coding of moving pictures and associated audio
- Digital Storage Media Command and Control (DSM-CC) for session set up and remote control of a server, used in set top boxes for satellite and cable TV
- Advanced Audio Coding (AAC) for multi-channel audio
- 4:2:2 profile for TV production studios
- Provisions for Intellectual Property Management and Protection (IPMP)
- Applications: digital TV set top boxes, DVD
- Transport Stream version
- Patent issues

# MPEG-4 — ISO/IEC 14496

- Coding of audiovisual objects
- MPEG-4 defines how to *represent* content
  - ♣ – ancestry: VRML
  - ♣ – interoperability of content structure
    - ➔ AFX — Animation Framework eXtension
    - ➔ XMT — textual XML format for SMIL, Web3D, etc.
  - ♣ adapt transparently to device capabilities
    - ➔ FSG — Fine Granularity Scalability
- Extensions of AAC and IPMP, Studio Profile
- MP4 and AVC file formats, multi-user environment
- Patent issues



# MPEG-7 — ISO/IEC 15938

- Multimedia content description interface
- MPEG-7 specifies how to *describe* content
  - ♣ describe content way beyond metadata
  - ♣ facilitate content management, in particular searching

# MPEG-21 — ISO/IEC (18034) 21000

- Define the technology needed to support **Users** to exchange, access, consume, trade and otherwise manipulate **Digital Items** in an efficient, transparent and interoperable way

# Current situation

- Situation: No complete solutions exist that allow different communities (content, financial, communications etc.), each with their own models, rules, procedures and content formats to interact efficiently.
- The multimedia content delivery chain encompasses different “players” (content creation, production, delivery etc.).
- To support this, the content has to be identified, described, managed and protected.
- Purpose: MPEG-21 MM-Framework shall enable interoperability in this situation.

# MPEG-21 "7 Elements"(1/2)

- Digital Item Declaration
  - ♣ A uniform and flexible abstraction and interoperable schema for declaring Digital Items
- Digital Item Identification and Description
  - ♣ A framework for identification and description of any entity regardless of its nature, type or granularity
- Content Handling and Usage
  - ♣ Provide interfaces and protocols that enable creation, manipulation, search, access, storage, delivery, and reuse of content across the content distribution and consumption value chain

# MPEG-21 "7 Elements" (2/2)

- Intellectual Property Management and Protection
  - ♣ The means to enable content to be persistently and reliably managed and protected across a wide range of networks and devices
- Terminals and Networks
  - ♣ The ability to provide interoperable and transparent access to content across network and terminal
- Content Representation
  - ♣ How the media resources are represented
- Event Reporting
  - ♣ The metrics and interfaces that enable Users to understand precisely the performance of all reportable events within the framework

# MPEG-21 scope

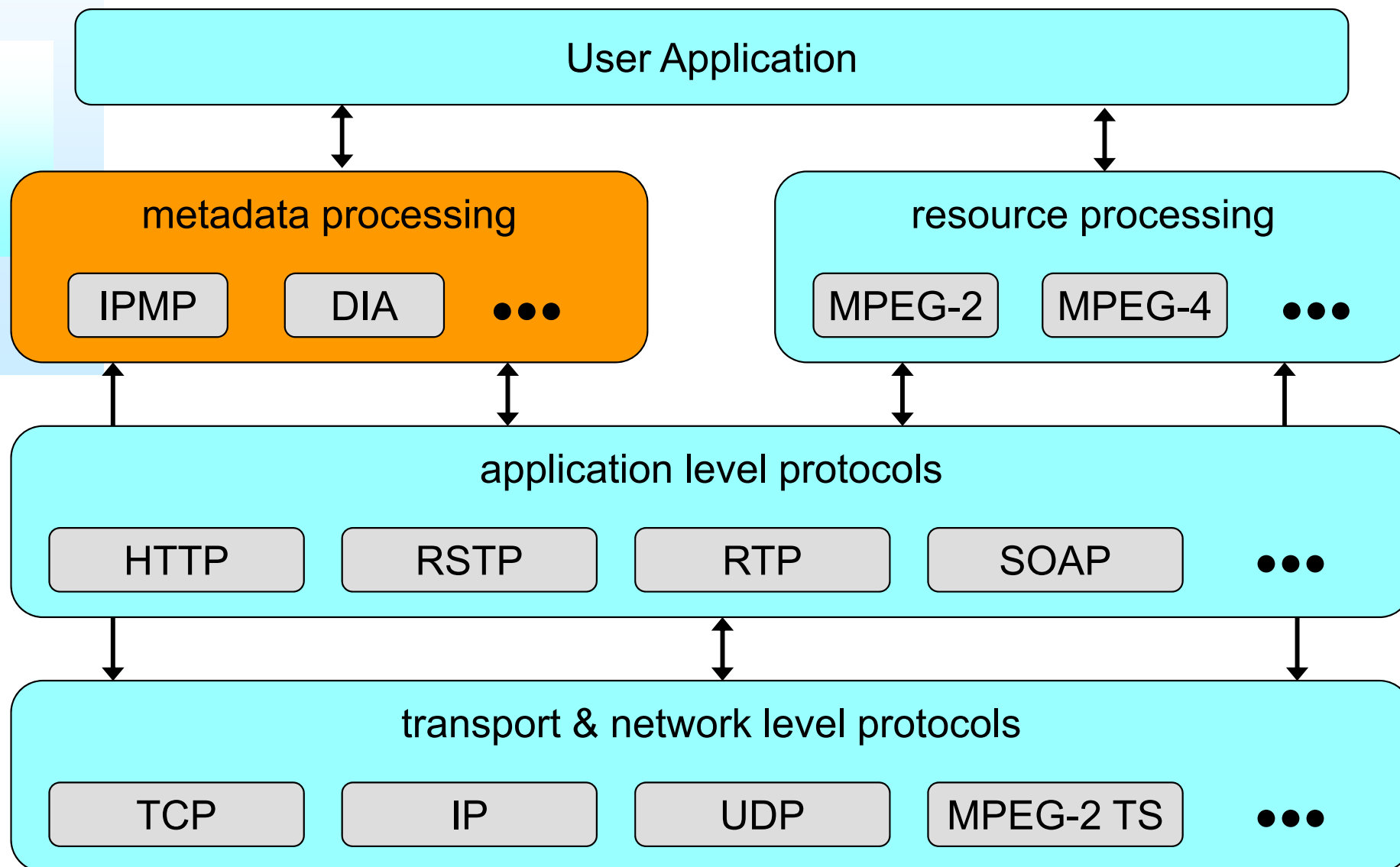

# MPEG-21 Digital Item

- Structured digital objects, including a standard representation and identification, and metadata
- Fundamental unit of distribution and transaction within the MPEG-21 framework
- No further technical meaning

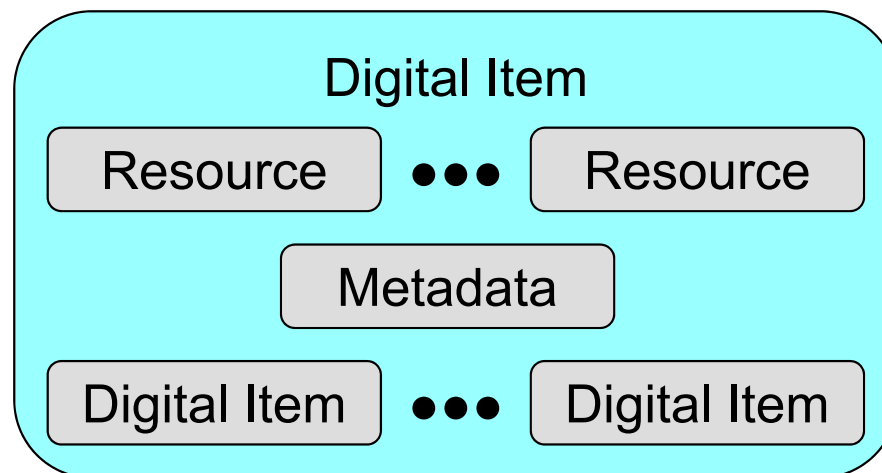

# Example of Digital Item

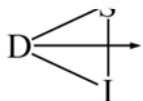
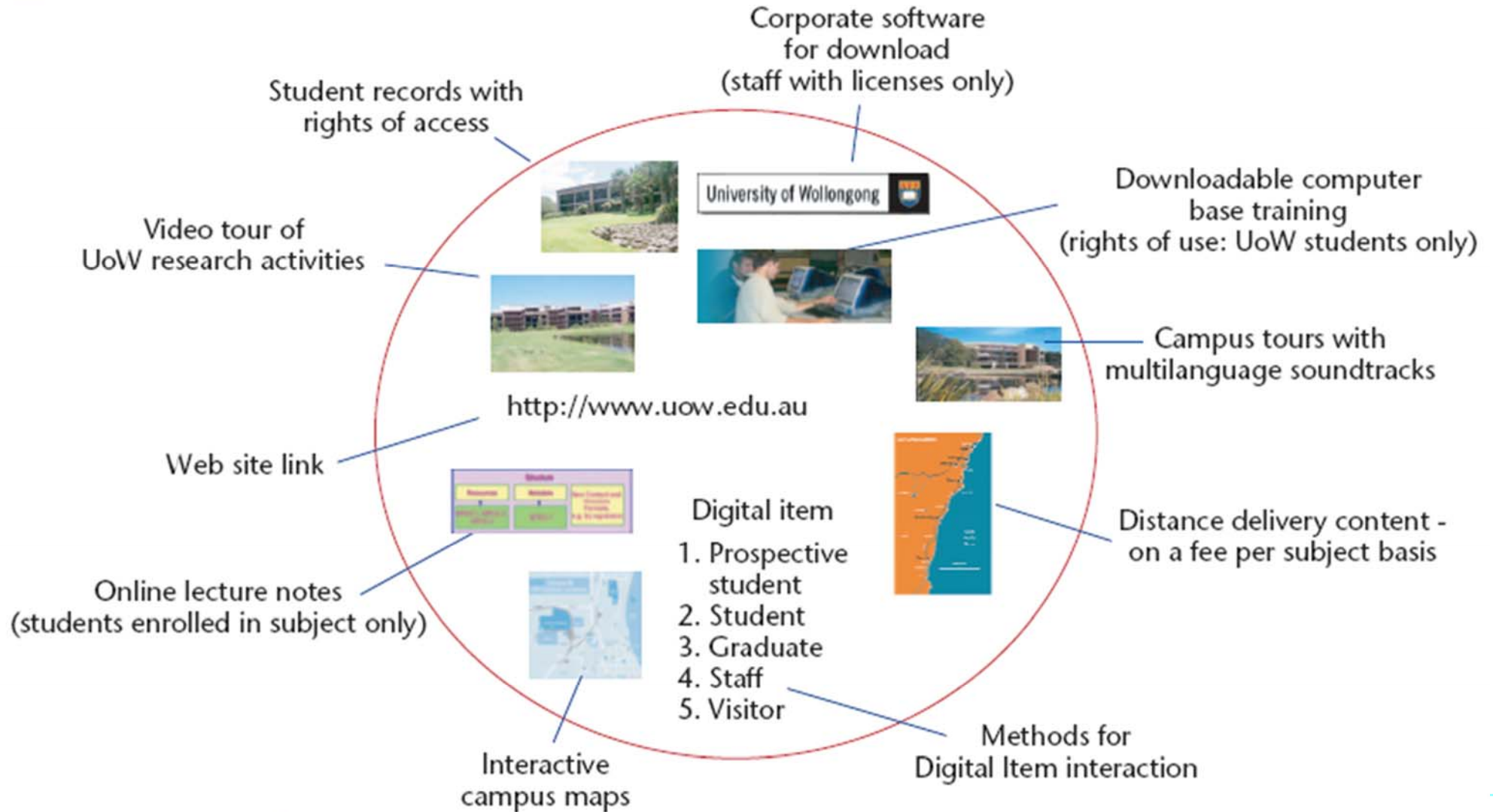



# MPEG-21 User

- A **User** is any entity that interacts in the MPEG-21 environment or makes use of a Digital Item
  - ♣ Users include individuals, consumers, communities, organisations, corporations, consortia, governments and other standards bodies and initiatives around the world.
- Users are identified specifically by their relationship to another User for a certain interaction
- MPEG-21 makes no distinction between a “content provider” and a “consumer” — both are Users
  - ♣ A single entity may use content in many ways
  - ♣ however, a User may assume specific or even unique rights and responsibilities according to their interaction with other Users within MPEG-21

# Specification parts of MPEG-21 (1/6)

1. Vision, technologies and strategies
  - describes the multimedia framework and its architectural elements
2. Digital Item Declaration
  - provides a uniform and flexible abstraction and interoperable schema for declaring Digital Items
3. Digital Item Identification
  - defines the framework for identifying any entity regardless of its nature, type, or granularity

# Specification parts of MPEG-21 (2/6)

## 4. Intellectual Property Management and Protection (IPMP)

- provides the means to reliably manage and protect content across networks and devices

## 5. Rights Expression Language

- specifies a machine-readable language that can declare rights and permissions using the terms as defined in the Rights Data Dictionary

## 6. Rights Data Dictionary

- specifies a dictionary of key terms required to describe users' rights

# Specification parts of MPEG-21 (3/6)

## 7. Digital Item Adaptation

- defines description tools for usage environment and content format features that might influence the transparent access to the multimedia content

## 8. Reference Software

- includes software that implements the tools specified in the MPEG-21 Spec.

## 9. File Format

- defines a file format for storing and distributing Digital Items.

# Specification parts of MPEG-21 (4/6)

## 10. Digital Item Processing

- defines mechanisms for standardized and interoperable processing of the information in Digital Item.

## 11. Evaluation Methods for Persistent Association Tools

- This Technical Report documents best practice in the evaluation of persistent association technologies, i.e., technologies that link information to identify and describe content using the content itself.

## 12. Test Bed for MPEG-21 Resource Delivery

- provides a software-based test bed for delivering scalable media and testing/evaluating this scalable media delivery in streaming environments.

# Specification parts of MPEG-21 (4/6)

## 13. Scalable Video Coding

- A video coding technology providing flexible scalability of a single bit-stream allows seamless integration of servers, heterogeneous networks, terminals, acquisition and storage devices which have different characteristics in the MPEG-21 multimedia framework

## 14. Conformance

- Provide suitable criteria to evaluate conformance to MPEG-21 parts of a complaint system

## 15. Event Reporting

- Specifies how to express ER-Request and Event Report and how they are represented as digital item

# Specification parts of MPEG-21 (4/6)

## 16. Binary Format

- Specifies the MPEG-21 binary format which is an alternative serialization format of MPEG-21 descriptions as specified within other MPEG-21 parts

## 17. Fragment Identification for MPEG Media Types

- Specifies a normative syntax for URI Fragment Identifiers to be used for addressing parts of any resource of given Internet Media Types

# MPEG-21 Part 1 — Vision

- Define a multimedia framework to enable transparent and augmented use of multimedia resources across a wide range of networks and devices
  1. Provide a vision
  2. Facilitate integration and harmonization of technologies
  3. Provide a strategy for achieving a framework through collaboration





# Users and content

- MPEG-21 Part 1 sets out the User requirements in the multimedia framework
- A user is any entity that interacts with the MPEG-21 environment, regardless of the intent and function. The dual is that MPEG-21 mediates between Users to allow transaction related to Digital Items
- The granularity spans domains of several orders of magnitude, from terminals on a backbone to devices on slow wireless links, from digital cinema theatre screens to mobile phone displays, from valuable boxing matches to pragmatic MRI scans, etc.
- Ease of use is a condition sine qua non for adoption of the general public; this is a requirement for interoperability and transparent interfaces, indicated by the dashed line

# The need for harmonization

- Unlike previous MPEG-1 and 2 standards, which were mostly about codecs, a framework spans a very wide area, which no single player can own, control, or even just design
- Each player has intellectual assets or knowledge in a small number of fields —
  - ♣ MPEG-21 is not about who has the best technology, rather
  - ♣ it is about “owners” of a field negotiating on interfaces that allow interoperability transparent to the User but leaving sufficient room for “owners” to deploy differentiating technologies that allow them to realize a profit.
  - ♣ This process is called **harmonization**

# MPEG-21 Part 2 — Digital Item Declaration

- Index a Digital Item
- Purpose: describe a set of abstract terms and concepts to form a useful model for defining Digital Items
- Three normative sections:
  - ♣ Model
    - ➔ set of abstract terms and concepts
  - ♣ Representation
    - ➔ normative description of syntax & semantics of DID elements
  - ♣ Schema
    - ➔ normative XML schema comprising the entire grammar of DID

# Digital Item Declaration in detail

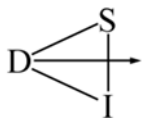
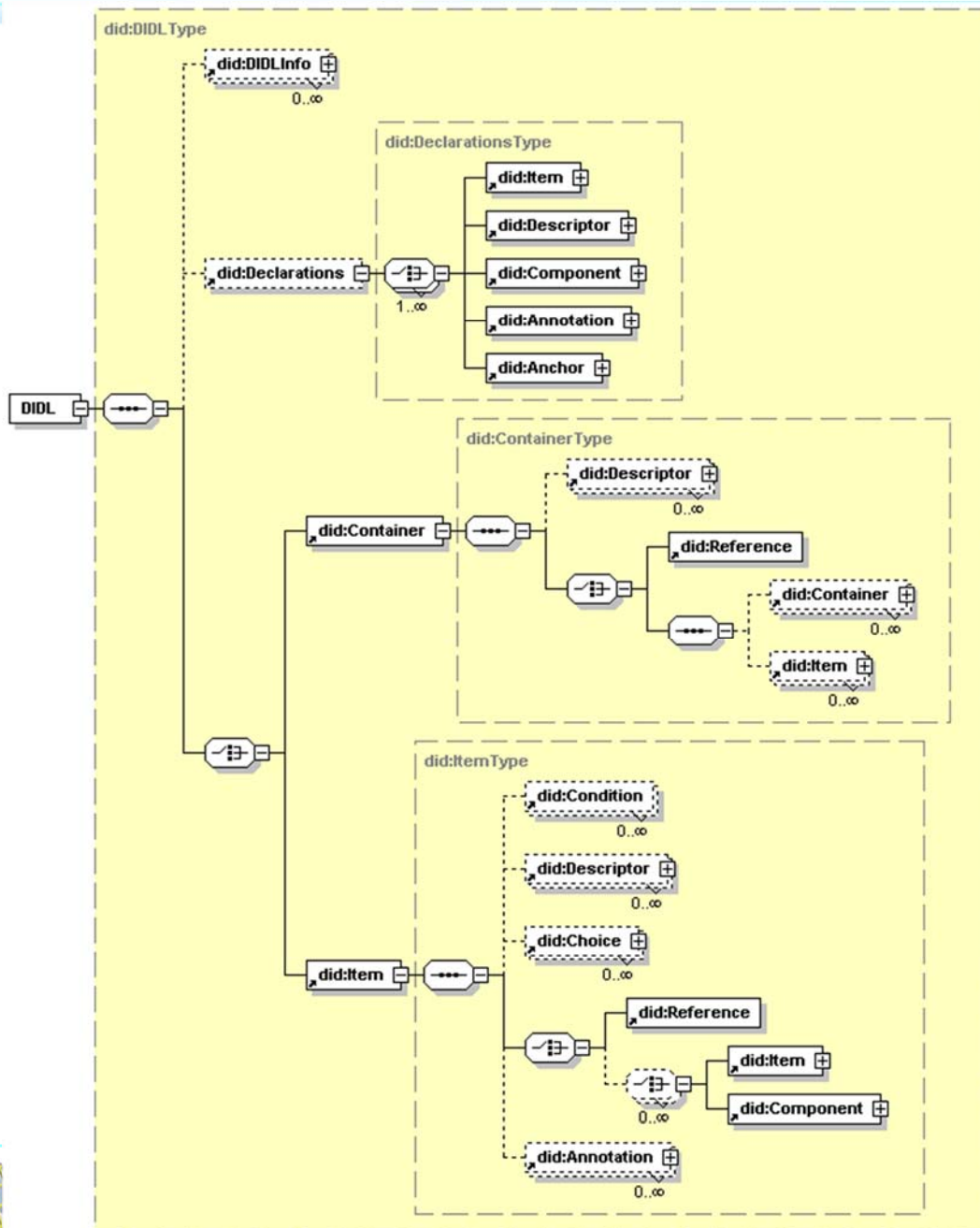

# Digital Item Declaration example

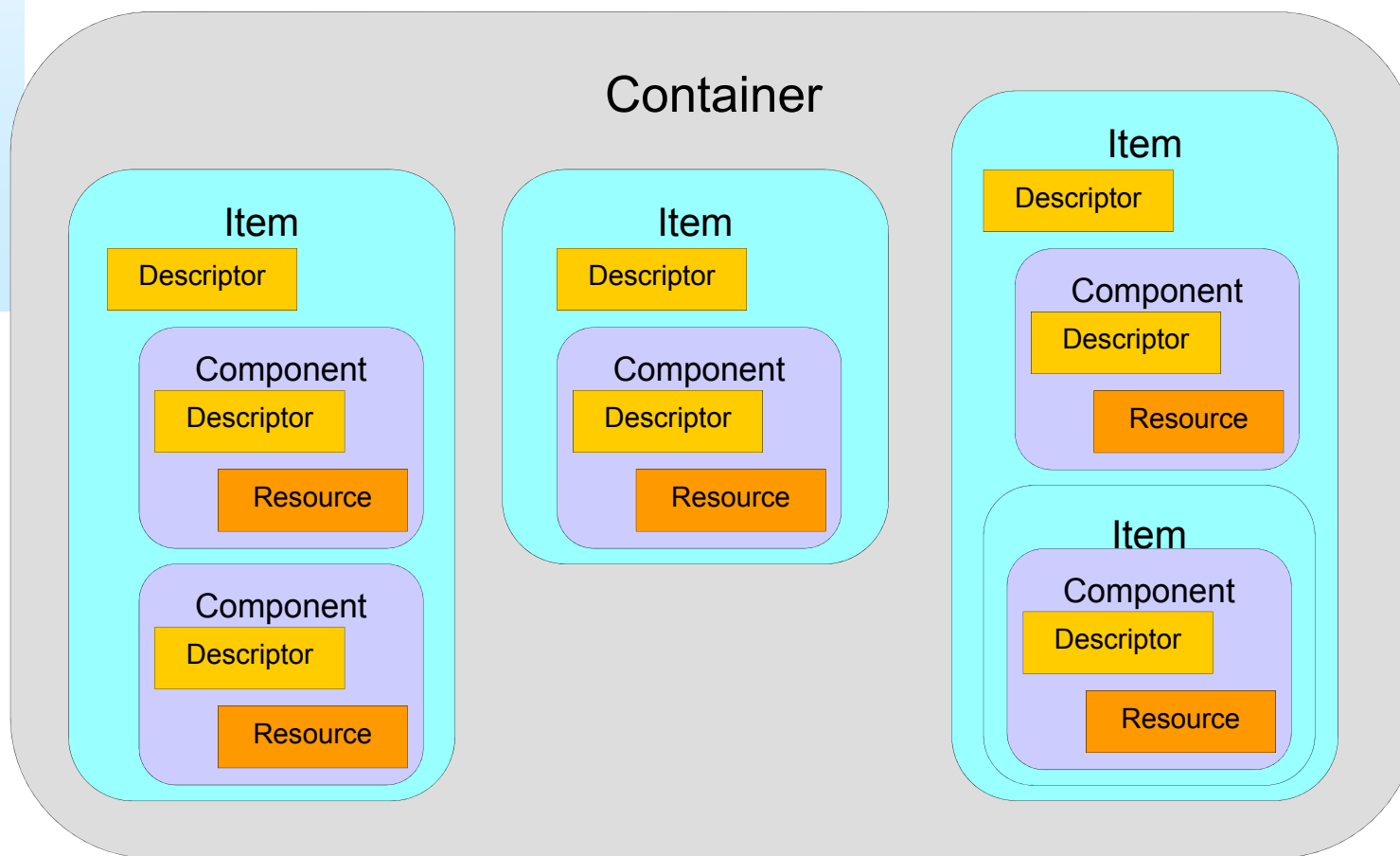

# MPEG-21 Part 3 — Digital Item Identification

- The scope of the Digital Item Identification (DII) specification includes:
  - ♣ How to uniquely identify Digital Items and parts thereof (including resources)
  - ♣ How to uniquely identify IP related to the Digital Items (and parts thereof), for example abstractions
  - ♣ How to uniquely identify Description Schemes
  - ♣ How to use identifiers to link Digital Items with related information such as descriptive metadata
  - ♣ How to identify different types of Digital Items

# DII example: MPEG-21 music album

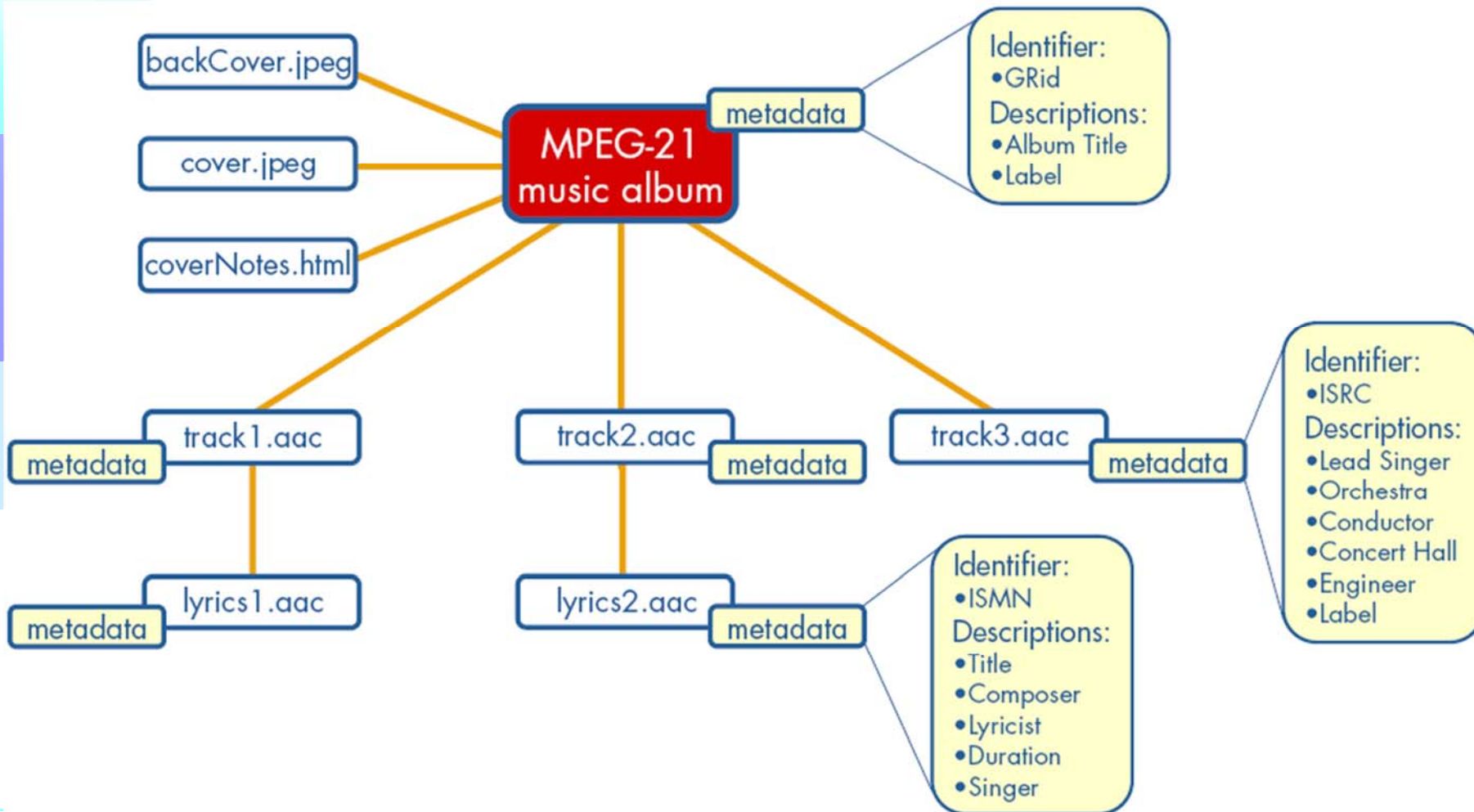

# DII and DID relation

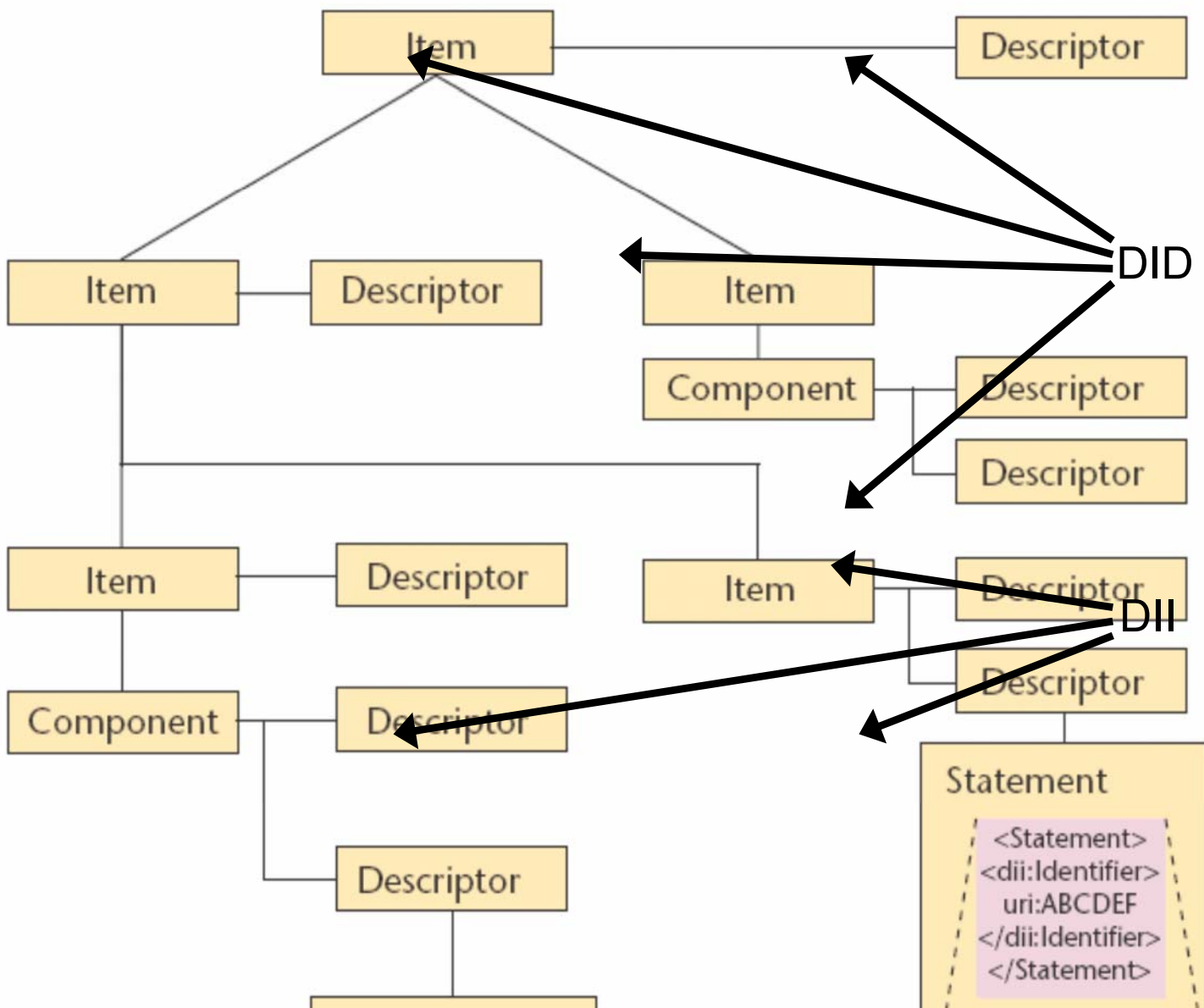



# MPEG-21 Part 4 — IPMP

- Improvements over MPEG-4 IPMP:
  - ♣ Internetworking
  - ♣ IPMP tool retrieval & authentication
  - ♣ Integration of Rights Expressions (RDD & REL)
- Intellectual Property Management and Protection involves the enforcement of REL permissions
  - ♣ IPMP shall consult REL before any actions are taken in the User's system
- REL: What is protected? What right applies?  
IPMP: How is it protected?

# IPMP using 'hooks' approach

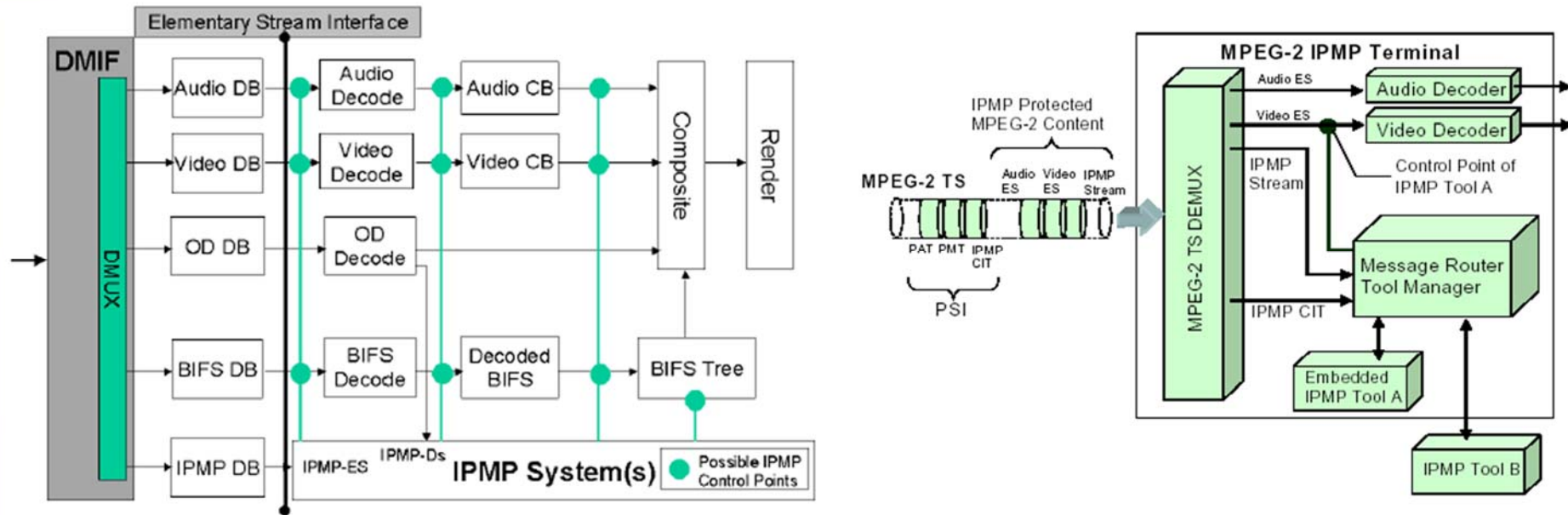

- IPMP in MPEG 2 and 4 (version 1) used the 'hooks' approach
- Plug-in a proprietary IPMP system
- Embed information into content streams that informs the terminal which proprietary IPMP system to use
- The reason was cost/benefit trade-off, one size did not fit all (e.g. TV and PDA)
- Downside: Limits interoperability, heavier terminal environment, risk many similar MPEG devices being built without inter-working

# New IPMP approach (1/2)

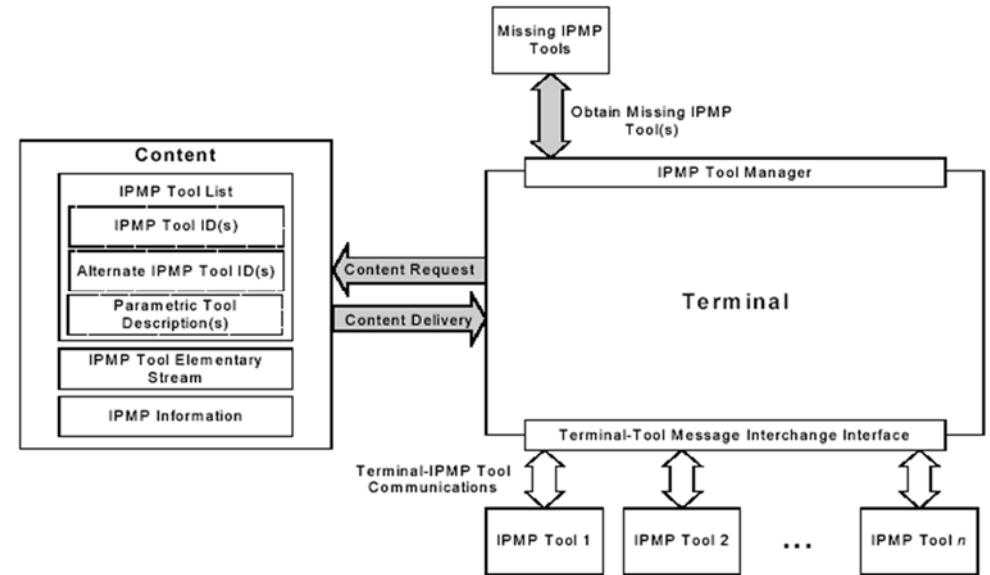
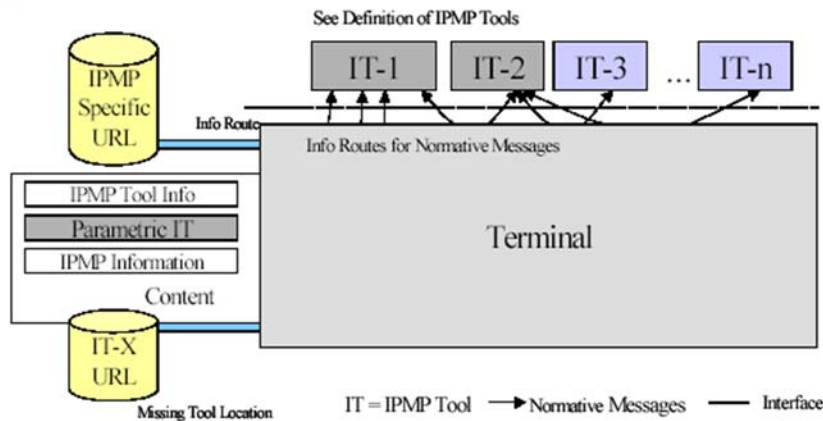

- More generalized architecture
- Provider lists authentication methods, recipient selects one
- Terminal can get IPMP Tools embedded in content or by downloading it
- Still based on hooking but uses Message Routing Service to simplify
- Audit agencies can provide Trust and Security metadata

# New IPMP approach (2/2)

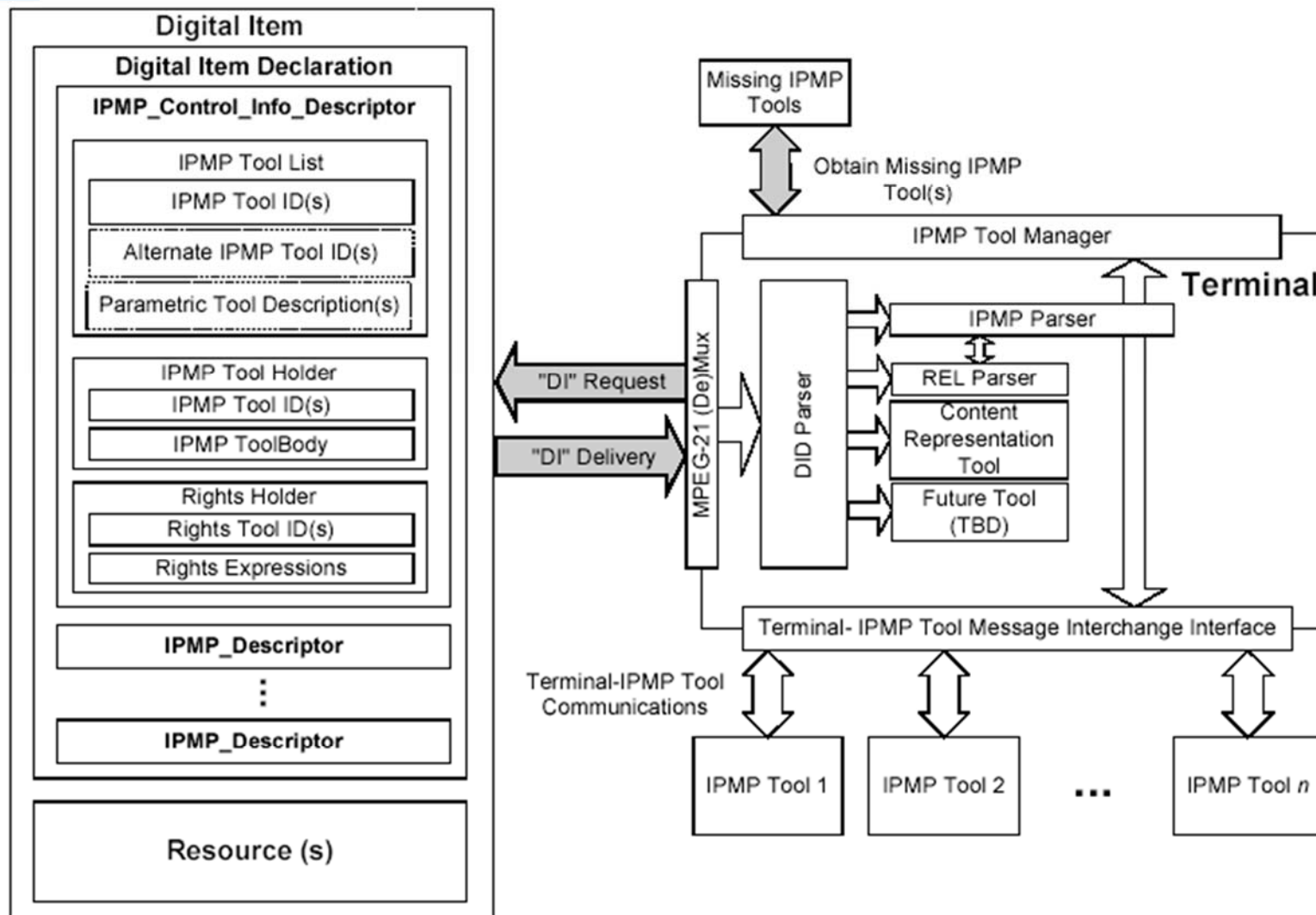

# MPEG-21 Part 5 — REL

- Rights Expression Language
- A machine-readable language
- Can declare rights and permissions
- Uses terms defined in the Rights Data Dictionary

# MPEG-21 Part 5 — REL

- The Rights Expression Language consists of licenses and grants that give specific permissions to Users to perform certain actions on certain resources, given that certain conditions are met
  - ♣ Grants can also allow Users to delegate authority to others
- User's system shall parse and validate the RE
- User's system shall check permissions before any further action is done
- DID parser is responsible for discovering and identifying where to gather licenses
- REL licenses are wrapped in Digital Items



# REL data model

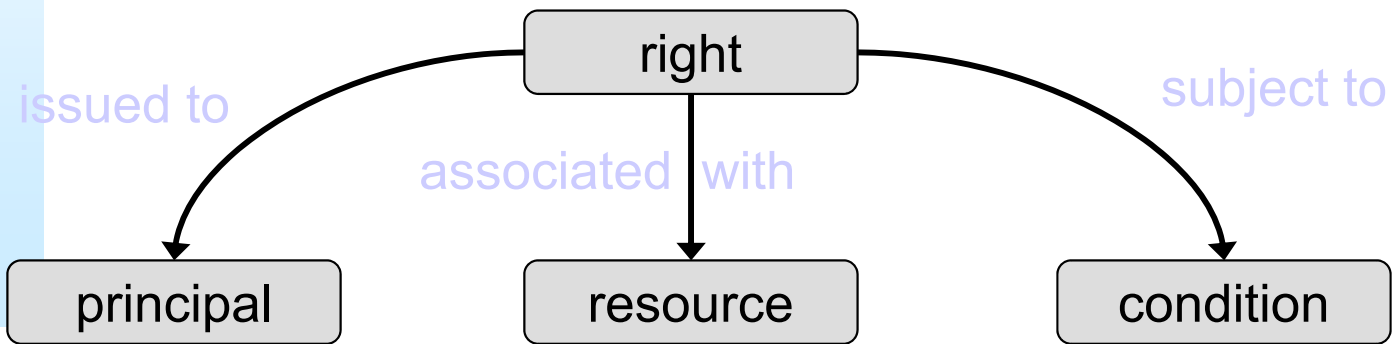

- REL grant consist of
  - ♣ principal to whom grant is issued
  - ♣ rights the grant specifies
  - ♣ resource to which right in grant applies
  - ♣ condition to be met before grant can be exercised

# REL – Principal

- A principal denotes the party that it identifies by information unique to that individual. Usefully, this is information that has some associated authentication mechanism by which the principal can prove its identity. The Principal type supports the following identification technologies:
  - ♣ A principal that must present multiple credentials, all of which must be simultaneously valid, to be authenticated.
- A keyHolder, meaning someone identified as possessing a secret key such as the private key of a public / private key pair.
- Other identification technologies that may be invented by others.



# REL – Right

- A right is the "verb" that a principal can be granted to exercise against some resource under some condition. Typically, a right specifies an action (or activity) or a class of actions that a principal may perform on or using the associated resource.
- MPEG REL provides a right element to encapsulate information about rights and provides a set of commonly used, specific rights, notably rights relating to other rights, such as issue, revoke and obtain. Extensions to MPEG REL could define rights appropriate to using specific types of resource. For instance, the MPEG REL content extension defines rights appropriate to using digital works (e.g., play and print)



Condition = November 2003



Resource = Ocean Wilds



Principal = Alice



Right = Play

*Figure 2. Elements involved in the license allowing an owner of a DVD player (Alice) to plays a movie (Ocean Wilds) in November 2003.*

# MPEG-21 Part 6 — Rights Data Dictionary

- Set of clear, consistent, structured, integrated and uniquely identified Terms to support REL
- Specification of dictionary structure and methodology to create dictionary
- Dictionary is prescriptive, inclusive, and has audit provisions
- Legal definitions are mapped from other Authorities
- Supports mapping & transformation of metadata from terminology of one namespace (or Authority) into that of another namespace in automated or partially-automated way
- Dictionary is based on a logical model, the Context Model, which is the basis of the dictionary ontology

# MPEG-21 Part 7 — Digital Item Adaptation

- Goal: achieve transparent interoperable access to distributed multimedia content
- Enable ad hoc formation of User communities in which contents is shared with agreed or contracted
  - ♣ Quality
  - ♣ Reliability
  - ♣ Flexibility
  - ♣ Diversity
- Guaranteed user experience

# Examples for Videos

- Temporal scaling
  - ♣ Reduce number of VOPs in the video resource
- Spatial scaling
  - ♣ Reduce the number of pixels in an image
- Frequency scaling
  - ♣ Reduce the number of DCT coefficients
- Color Scaling
  - ♣ Reduce the number of colors available
- Modality Translation
  - ♣ conversion of the modality (e.g., image, text, audio, graphics) of the source resource

# Concept of Digital Item Adaptation

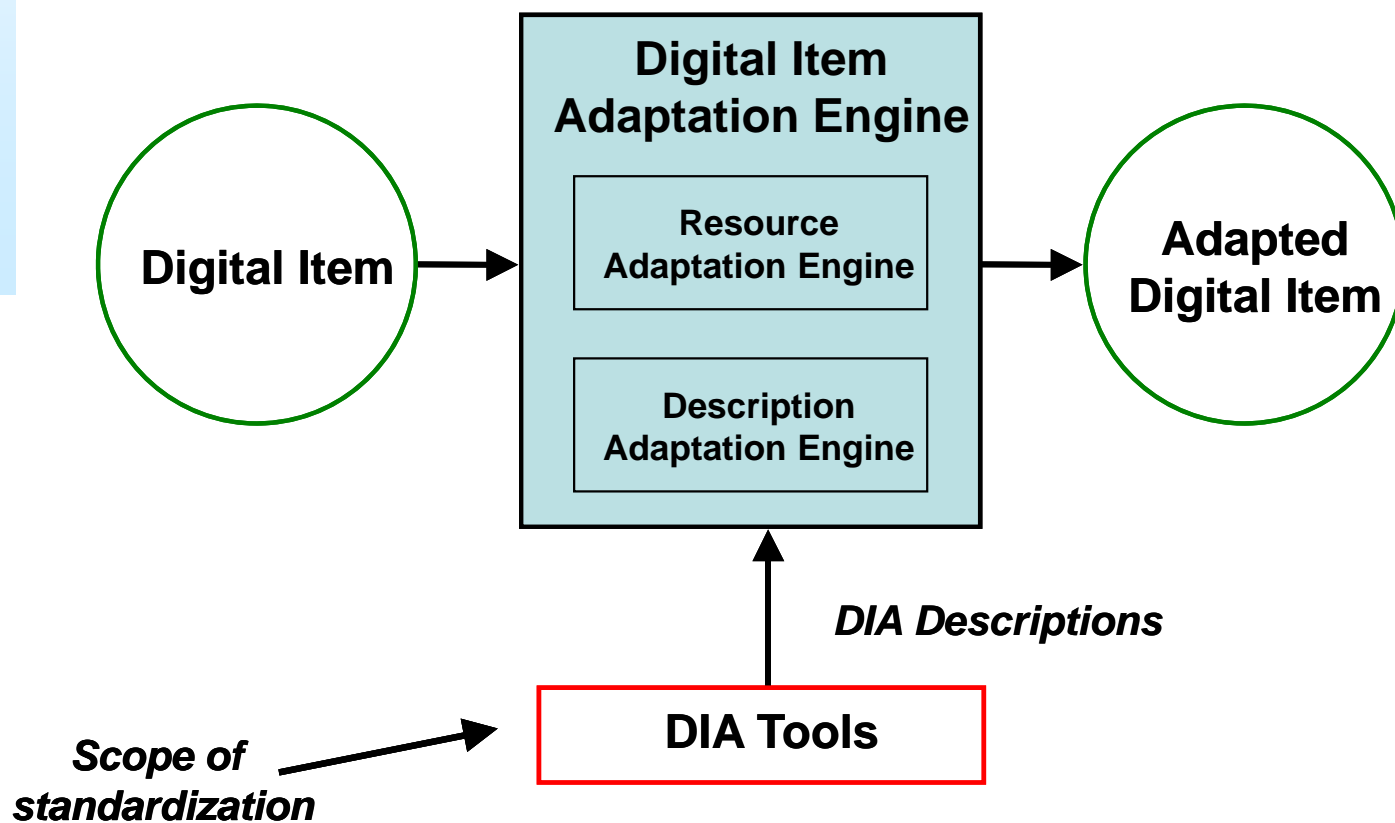

# Relation between DIA and other MPEG-21parts

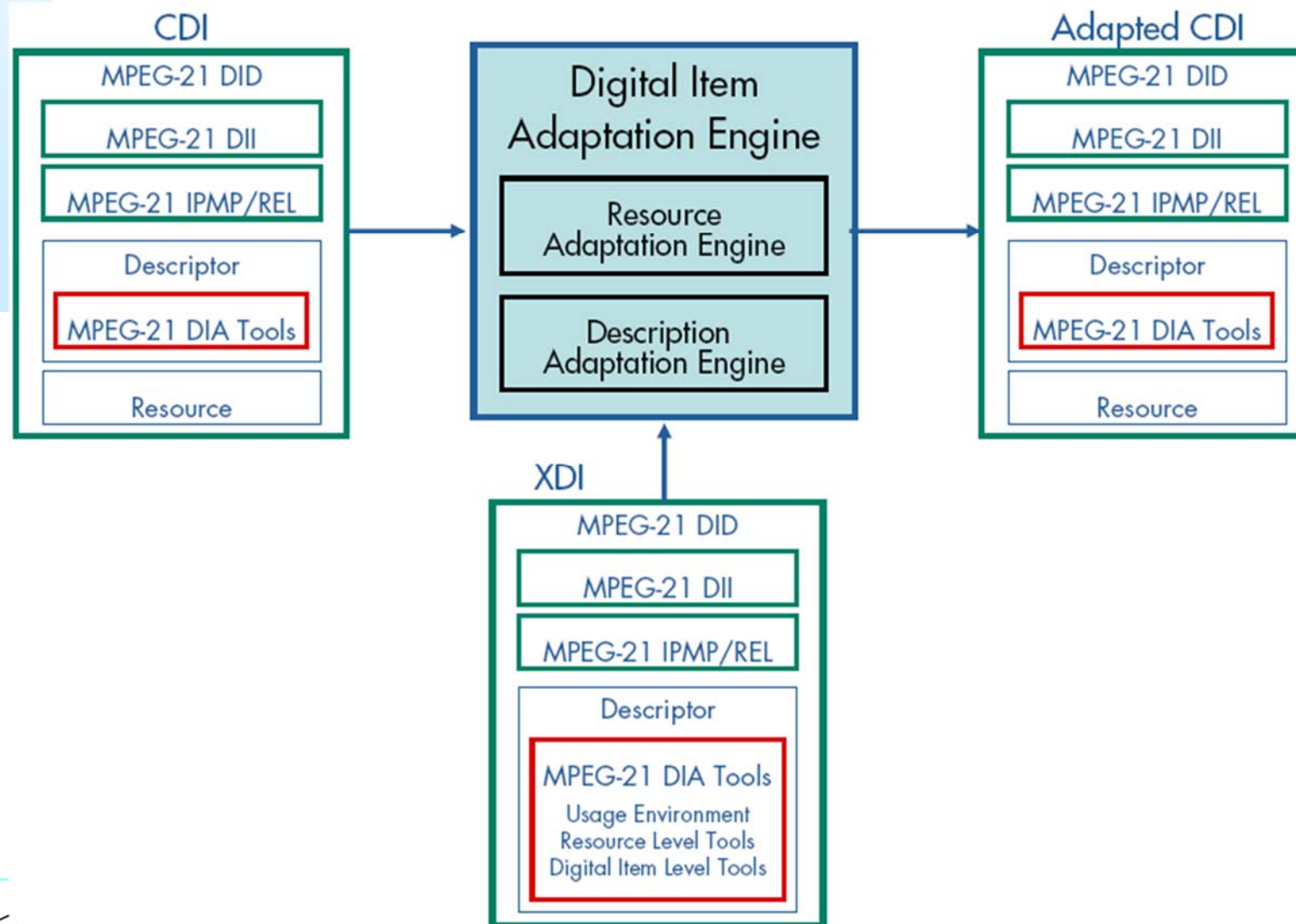

# Scope of standardization

- User Characteristics
- Terminal Capabilities
- Network Characteristics
- Natural Environment Characteristics
- Resource Adaptability
- Session Mobility



# Overview of DIA Tools

## Usage Environment Description Tools

- User Characteristics
- Terminal Capabilities
- Network Characteristics
- Natural Environment Characteristics

## Digital Item Resource Adaptation Tools

- Bitstream Syntax Description
- Terminal and Network QoS
- Bitstream Syntax Description Link
- Metadata Adaptability

•BSDL (Bitstream Syntax Description Language)  
 •gBS Schema (generic Bitstream Syntax Schema)

•AdaptationQoS

•MetadataAdaptationHint

## Digital Item Declaration Adaptation Tools

- Session Mobility
- DIA Configuration



# Bitstream Syntax Description

- A BSD describes the syntax (high level structure) of a binary media resource
- BSDL: XML schema based language to design specific bitstream syntax schemas for particular media formats
- gBS schema: generic schema enabling the construction of resource format independent bitstream syntax descriptions

# Adaptation architecture

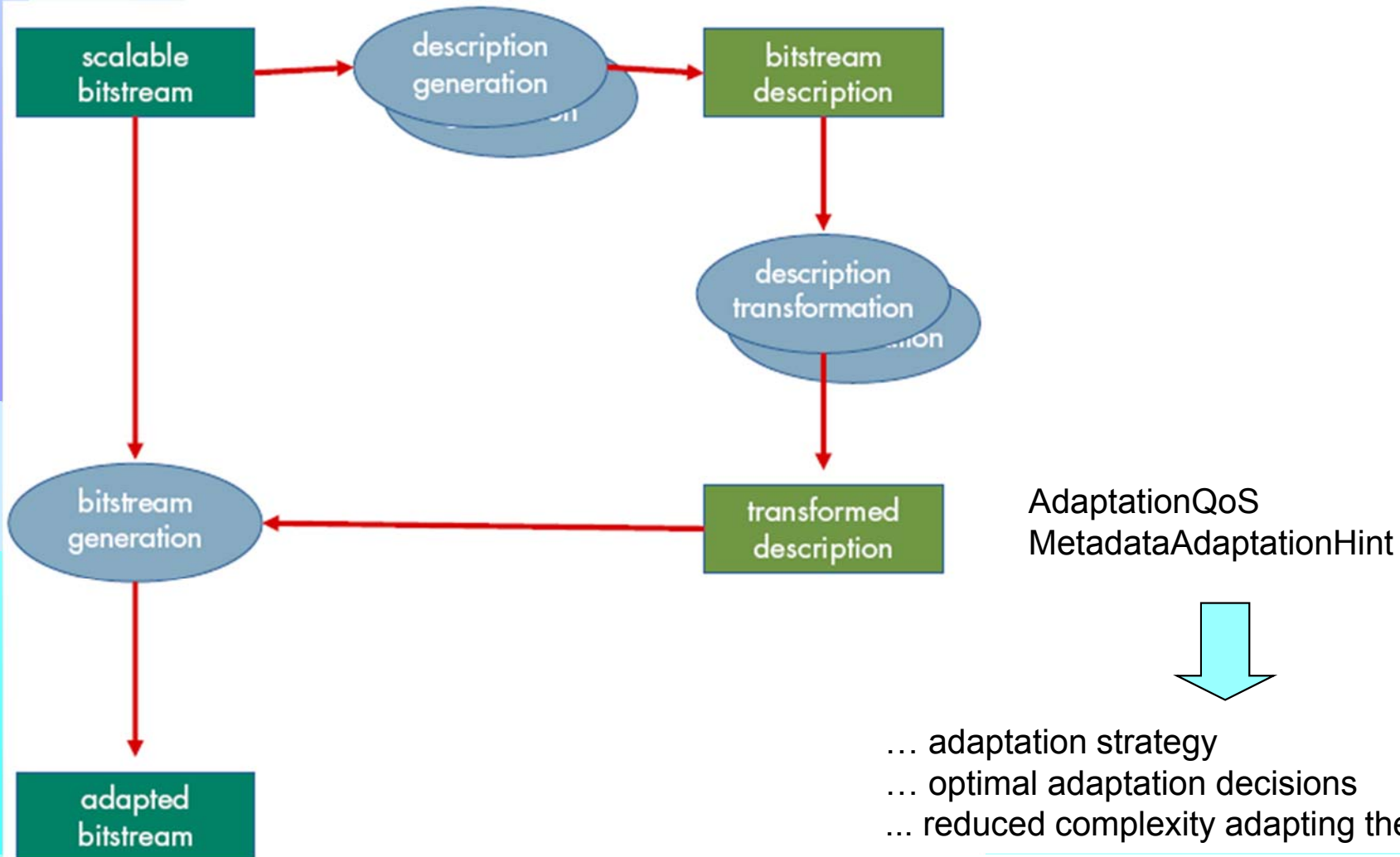

# Terminal and Network Quality of Service

- *AdaptationQoS* specifies the relationship between constraints and feasible adaptation operations
- Constraints: *BandwidthInKbps*, *ComputationTimeInMillisecs*
- Utilities (qualities): *PSNRIndB*
- Adaptation Methods:
  - ♣ *frameDroppingAndOrCoefficientDropping*, requantization,
- *fineGranularScalability*, *waveletReduction*, *spatialSizeReduction*
- UtilityFunction:
  - ♣ describes possible adaptation operators and associated qualities using a set of constraint points as indexes
  - ♣ Linear interpolation is assumed between constraint points
- LookUpTable:
  - ♣ additional multi-dimensional sets of data to support more elaborate adaptation scenarios
- StackFunction
  - ♣ tool for describing the data in numerical function format

# Metadata Adaptability

- *MetadataAdaptationHint* describes adaptation hint information pertaining to metadata within a digital item
- Hint: a set of syntactical elements with prior knowledge about the metadata that is useful for reducing the complexity of the metadata adaptation process

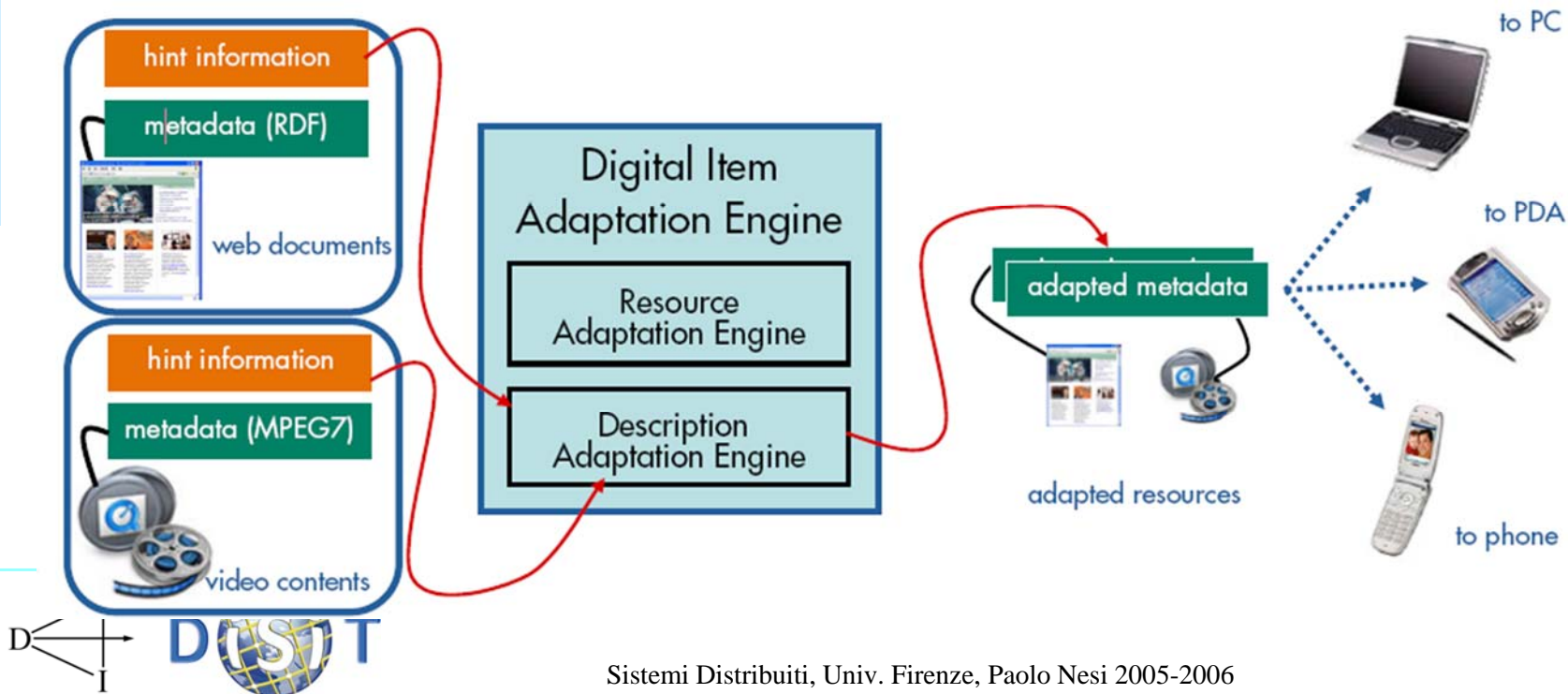

# AdaptationQoS - BSD Link

- In some cases it is convenient to specify intrinsic operations based on a universal model for scalable bit-streams. A specified operation can be seen as a **link** that is composed of a mapping condition between identified parameters and an operation, which is conducted if this mapping is fulfilled

parameters

AdaptationQoS

linking

link specification

bitstream description

markers

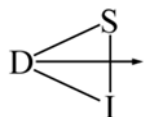

# (g)BSD, AdaptationQoS, and Link

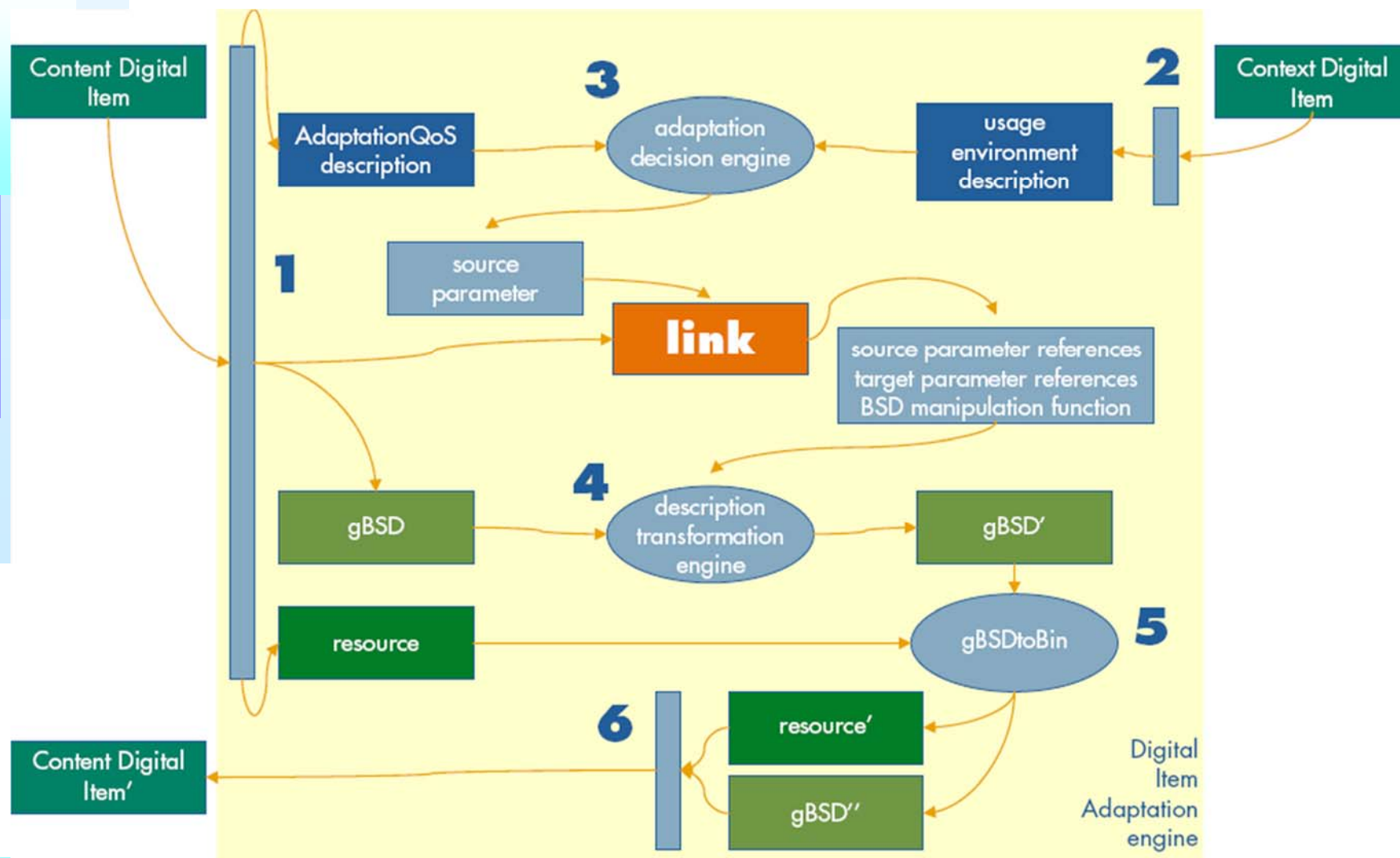

# MPEG-21 Part 8 — Reference Software

- Success of a standard depends on the availability of reference software
- Plan to use the software developed in Core Experiments (CE) as a basis
- Platform independence
- Future repository (requires membership)
  - ♣ <http://mpeg.nist.gov/cvsweb/MPEG-21/>
- Temporary repository
  - ♣ <http://www.titr.uow.edu.au/cgi-bin/mpeg-ref-sw.pl>



# MPEG-21 Part 9 — File Format

- An MPEG-21 file format shall be capable of storing MPEG-21 Digital Items
  - ♣ all components of the DI within a single file
- The MPEG-21 file format will inherit several concepts from MP4, in order to make ‘multi-purpose’ files possible

# MPEG-21 Part 10 — Digital Item Processing

- Digital Items act as a structure for organizing resources and its descriptions
- Need a mechanism for defining a set of operations by which a terminal can process a DI or DID
- Currently considering to specify a set of operations that can be used to process DIs: Digital Item Method
- A DIM defines an intended method for configuring, manipulating and/or validating a DI

# Methods vs. processing

- Interoperability of Digital Items means that terminals must handle the DIs in a consistent manner
- Digital Item Methods provide a way to specify a selection of preferred procedures by which the DI should be handled at the DI level
  - ♣ a menu of user interaction possibilities
- Digital Item Processing encompasses all aspects of processing a DI from an application perspective
- Applications build DIP environments around a fundamental DIME



# Digital Item processing terminology

- CDI — Content Digital Item
  - ♣ a DID containing the actual content
- DIBO — Digital Item Base Operation
- DIM — Digital Item Method
  - ➔ method that can be applied to a DID
  - ♣ DIME — DIM Engine
    - ➔ part of the terminal responsible for executing the DIM
  - ♣ DIML — DIM Language
- DIP — Digital Item Processing
- MI — Method Item
- PI — Processing Item
- XDI — Context Digital Item

# Digital Item Processing

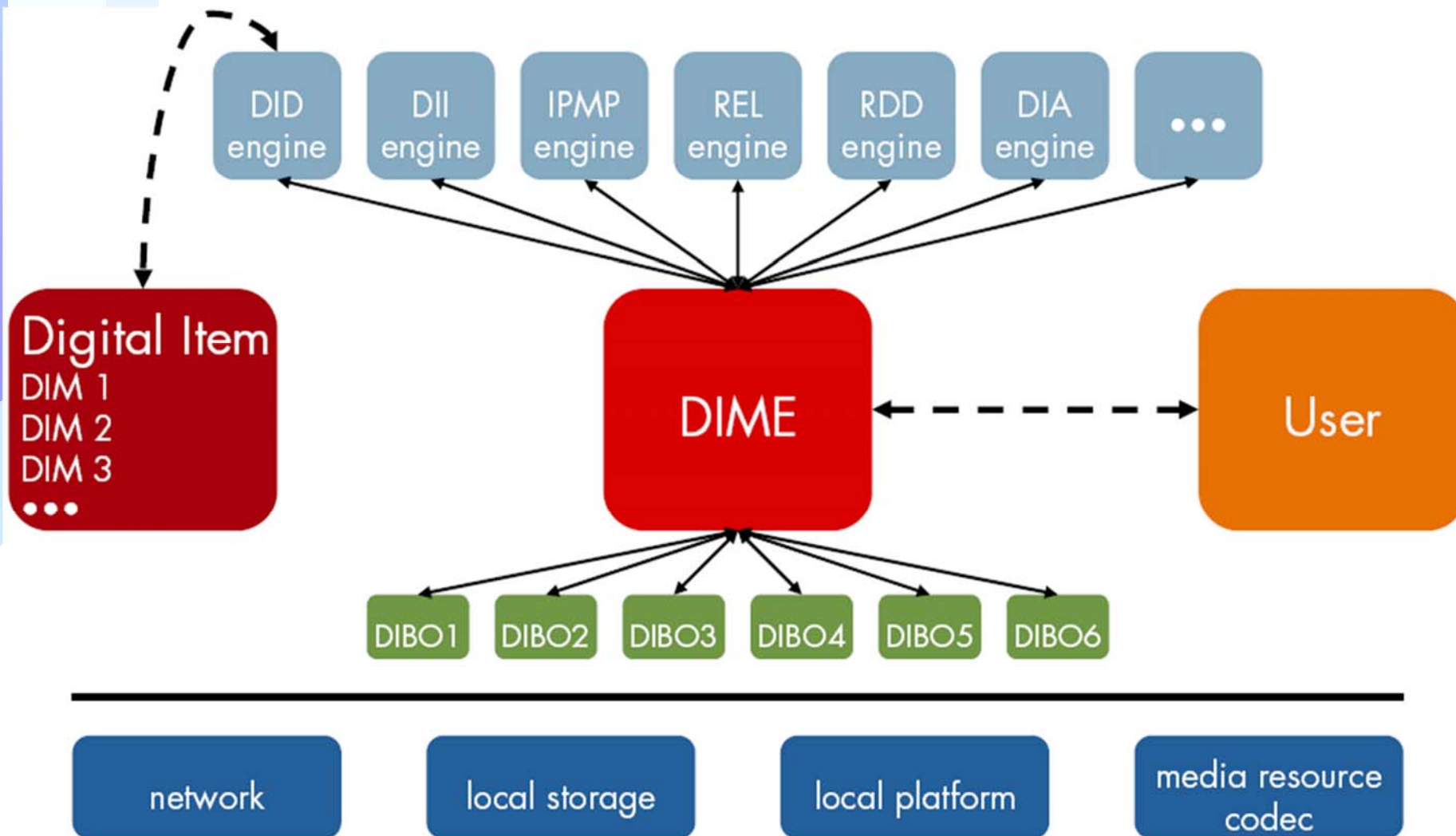

# DIP flow control

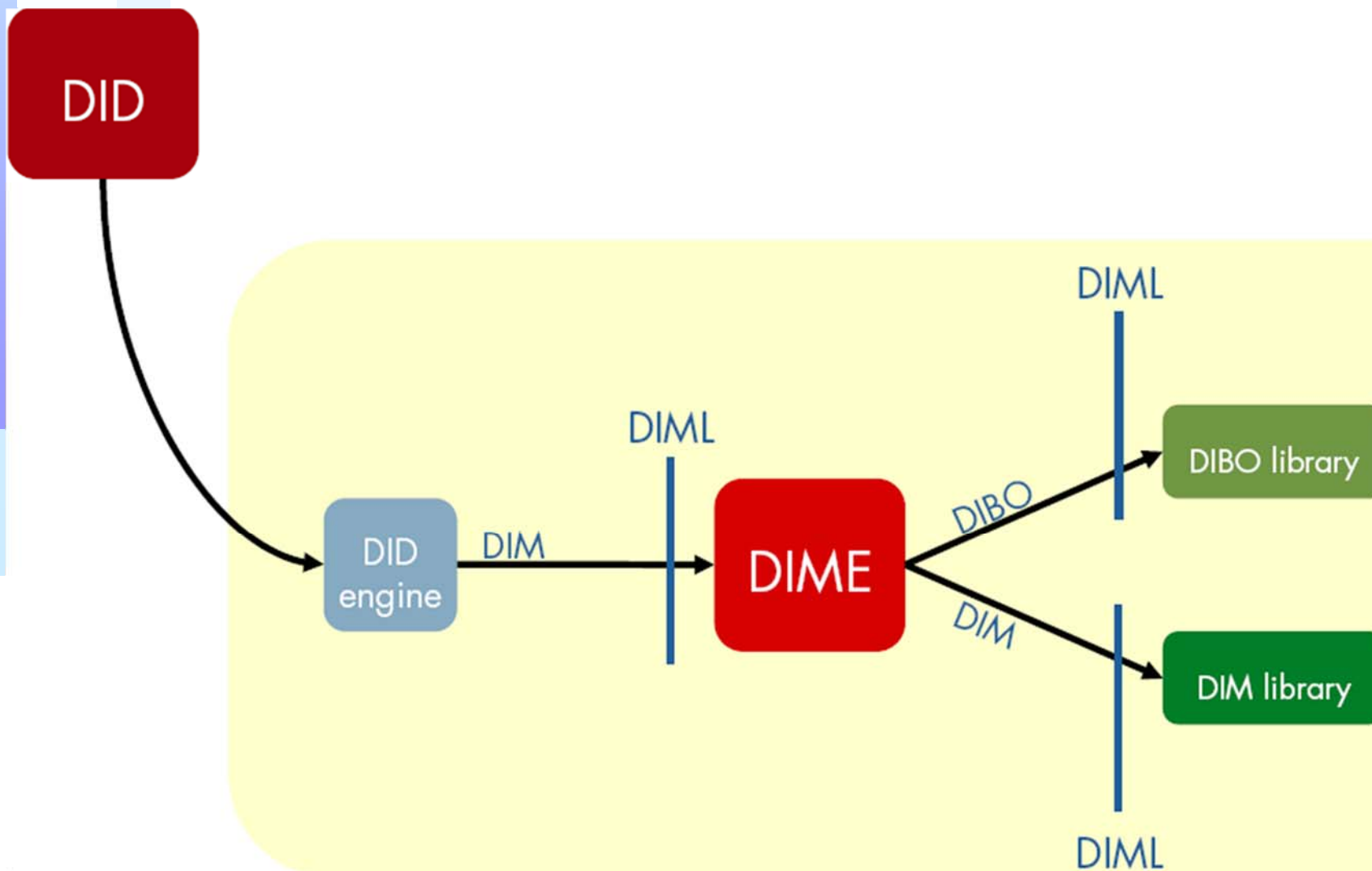

# MPEG-21 Part 15 — Event Reporting

- Standardise metrics and interfaces for performance of all reportable events in MPEG-21;
- Provide a means of capturing and containing these metrics and interfaces that refers to identified Digital Items, environments, processes, transactions and Users.
- Such metrics and interfaces will enable Users to understand precisely the performance of all reportable events within the framework. “Event Reporting” must provide Users a means of acting on specific interactions, as well as enabling a vast set of out-of-scope processes, frameworks and models to interoperate with MPEG-21.

# MPEG-21 Part 17 — Fragment Identification for MPEG Media Types

- Fragment Identification can be used to address the following media type:
  - ♣ audio/mpeg [RFC3003]
  - ♣ video/mpeg [RFC2045,RFC2046]
  - ♣ video/mp4 [draft-lim-mpeg4-mime-02]
  - ♣ audio/mp4 [draft-lim-mpeg4-mime-02]
  - ♣ application/mp4 [draft-lim-mpeg4-mime-02]
  - ♣ video/MPEG4-visual [draft-lim-mpeg4-mime-02]
  - ♣ application/mp21
- The syntax for URI Fragment Identifiers defined in this specification is based on the W3C XPointer Framework Recommendation and adds the ability to address:
  - ♣ Temporal, spatial and spatio-temporal locations
  - ♣ Logical unit(s) of a resource according to a given Logical Model
  - ♣ A byte range of a resource
  - ♣ Items or Tracks of an ISO Base Media File



# MPEG-21 Pros and Cons

## Pro

- ♣ International standard
- ♣ Broad commercial support for earlier MPEG specs
- ♣ Packages any type of complex digital object per OAIS
- ♣ Powerful and flexible means to express descriptive, structural, administrative, and other metadata

## Con

- ♣ Complex and highly technical
- ♣ Few tools currently exist
- ♣ Unclear now the extent to which spec will be adopted
- ♣ Strong emphasis on commercial rights protection?

# Conclusions

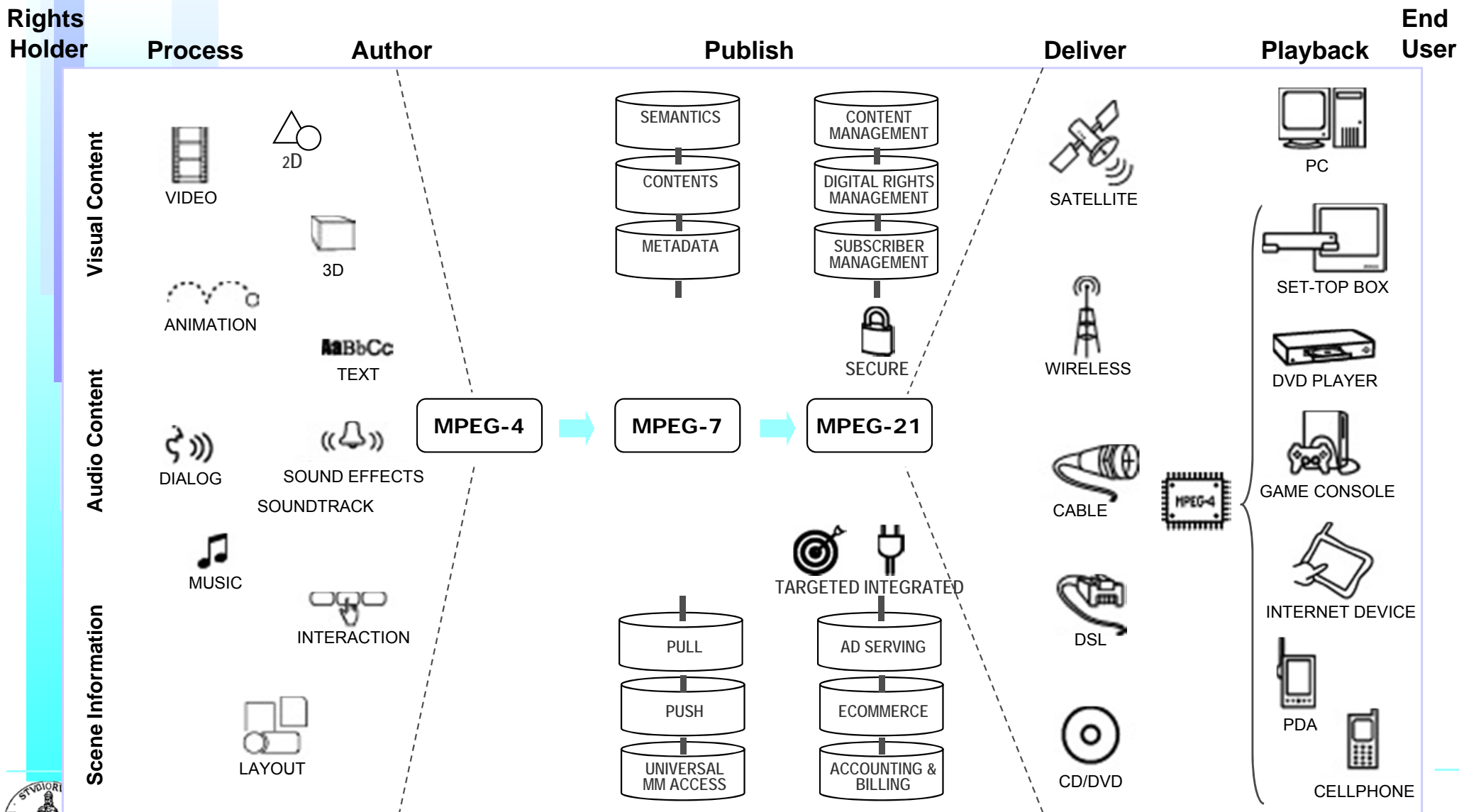

# Acknowledgment

- Thanks to all MPEG-21 Contributors for these slides and related material